

RAV4
2 0 1 5



NAVIGATION AND
MULTIMEDIA SYSTEM
OWNER'S MANUAL

© 2014 TOYOTA MOTOR CORPORATION

All rights reserved. This material may not be reproduced or copied, in whole or in part, without the written permission of Toyota Motor Corporation.

1	QUICK GUIDE	11
2	BASIC FUNCTION	31
3	AUDIO SYSTEM	65
4	VOICE COMMAND SYSTEM	123
5	INFORMATION	133
6	PERIPHERAL MONITORING SYSTEM	139
7	PHONE	151
8	NAVIGATION SYSTEM	191
9	Entune App Suite	259
	INDEX	275

About the following equipment, see the "Owner's Manual".

- Fuel consumption
- Vehicle customization settings

Introduction

NAVIGATION AND MULTIMEDIA SYSTEM OWNER'S MANUAL

This manual explains the operation of this system. Please read this manual carefully to ensure proper use. Keep this manual in your vehicle at all times.

The screen shots in this document and the actual screens of this system differ depending on whether the functions and/or a contract existed and the map data available at the time of producing this document.

Please be aware that the content of this manual may be different from this system in some cases, such as when the system's software is updated.

NAVIGATION SYSTEM (WITH NAVIGATION FUNCTION)

The Navigation System is one of the most technologically advanced vehicle accessories ever developed. The system receives satellite signals from the Global Positioning System (GPS) operated by the U.S. Department of Defense. Using these signals and other vehicle sensors, the system indicates your present position and assists in locating a desired destination.

The navigation system is designed to select efficient routes from your present starting location to your destination. The system is also designed to direct you to a destination that is unfamiliar to you in an efficient manner. The system uses AISIN AW maps. The calculated routes may not be the shortest nor the least traffic congested. Your own personal local knowledge or "short cut" may at times be faster than the calculated routes.

The navigation system's database includes Point of Interest categories to allow you to easily select destinations such as restaurants and hotels. If a destination is not in the database, you can enter the street address or a major intersection close to it and the system will guide you there.

The system will provide both a visual map and audio instructions. The audio instructions will announce the distance remaining and the direction to turn in when approaching an intersection. These voice instructions will help you keep your eyes on the road and are timed to provide enough time to allow you to maneuver, change lanes or slow down.

Please be aware that all current vehicle navigation systems have certain limitations that may affect their ability to perform properly. The accuracy of the vehicle's position depends on satellite conditions, road configuration, vehicle condition or other circumstances. For more information on the limitations of the system, refer to page 254.

TOYOTA MOTOR CORPORATION

IMPORTANT INFORMATION ABOUT THIS MANUAL

For safety reasons, this manual indicates items requiring particular attention with the following marks.

CAUTION

- This is a warning against anything which may cause injury to people if the warning is ignored. You are informed about what you must or must not do in order to reduce the risk of injury to yourself and others.

NOTICE

- This is a warning against anything which may cause damage to the vehicle or its equipment if the warning is ignored. You are informed about what you must or must not do in order to avoid or reduce the risk of damage to your vehicle and its equipment.

SYMBOLS USED IN ILLUSTRATIONS



Safety symbol

The symbol of a circle with a slash through it means “Do not”, “Do not do this” or “Do not let this happen”.

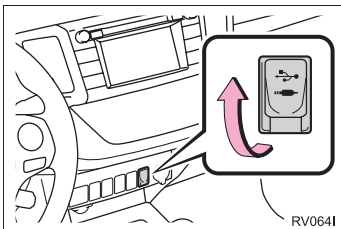

Arrows indicating operations

-  Indicates the action (pushing, turning, etc.) used to operate switches and other devices.

HOW TO READ THIS MANUAL

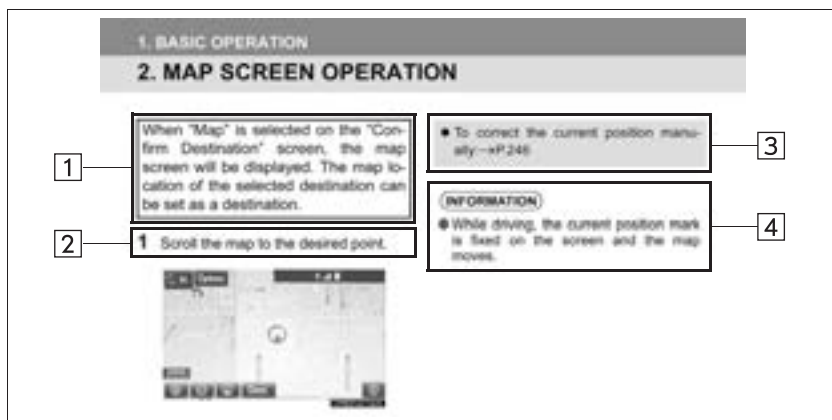

No.	Name	Description
1	Operational Outlines	An outline of the operation is explained.
2	Main Operations	The steps of an operation are explained.
3	Related Operations	A main operation's supplementary operations are described.
4	Information	Useful information for the user is described.

SAFETY INSTRUCTION (WITHOUT NAVIGATION FUNCTION)

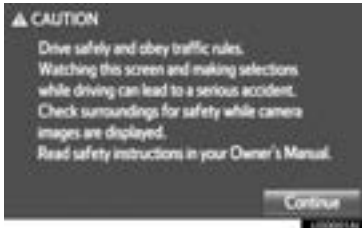

To use this system in the safest possible manner, follow all the safety tips shown below.

Do not use any feature of this system to the extent it becomes a distraction and prevents safe driving. The first priority while driving should always be the safe operation of the vehicle. While driving, be sure to observe all traffic regulations.

Prior to the actual use of this system, learn how to use it and become thoroughly familiar with it. Read the entire manual to make sure you understand the system. Do not allow other people to use this system until they have read and understood the instructions in this manual.

For your safety, some functions may become inoperable when driving. Unavailable screen buttons are dimmed.



CAUTION

- For safety, the driver should not operate the system while he/she is driving. Insufficient attention to the road and traffic may cause an accident.

SAFETY INSTRUCTION (WITH NAVIGATION FUNCTION)



To use this system in the safest possible manner, follow all the safety tips shown below.

This system is intended to assist in reaching the destination and, if used properly, can do so. The driver is solely responsible for the safe operation of your vehicle and the safety of your passengers.

Do not use any feature of this system to the extent it becomes a distraction and prevents safe driving. The first priority while driving should always be the safe operation of the vehicle. While driving, be sure to observe all traffic regulations.

Prior to the actual use of this system, learn how to use it and become thoroughly familiar with it. Read the entire manual to make sure you understand the system. Do not allow other people to use this system until they have read and understood the instructions in this manual.

For your safety, some functions may become inoperable when driving. Unavailable screen buttons are dimmed. Only when the vehicle is not moving, can the destination and route selection be done.



CAUTION

- For safety, the driver should not operate the system while he/she is driving. Insufficient attention to the road and traffic may cause an accident.
- While driving, be sure to obey the traffic regulations and maintain awareness of the road conditions. If a traffic sign on the road has been changed, route guidance may not have the updated information such as the direction of a one way street.

While driving, listen to the voice instructions as much as possible and glance at the screen briefly and only when it is safe. However, do not totally rely on voice guidance. Use it just for reference. If the system cannot determine the current position correctly, there is a possibility of incorrect, late, or non-voice guidance.

The data in the system may occasionally be incomplete. Road conditions, including driving restrictions (no left turns, street closures, etc.) frequently change. Therefore, before following any instructions from the system, look to see whether the instruction can be done safely and legally.

This system cannot warn about such things as the safety of an area, condition of streets, and availability of emergency services. If unsure about the safety of an area, do not drive into it. Under no circumstances is this system a substitute for the driver's personal judgement.

Use this system only in locations where it is legal to do so. Some states/provinces may have laws prohibiting the use of video and navigation screens next to the driver.

TABLE OF CONTENTS

1 QUICK GUIDE

1. BASIC FUNCTION	12
OVERVIEW BUTTONS	12
“Apps” SCREEN	14
HOME SCREEN	16
2. QUICK REFERENCE	20
“Setup” SCREEN	20
3. NAVIGATION OPERATION	22
REGISTERING HOME	22
REGISTERING PRESET DESTINATIONS.....	24
OPERATION FLOW: GUIDING THE ROUTE	26
SETTING HOME AS THE DESTINATION	27
4. FUNCTION INDEX	28
FUNCTION INDEX	28

2 BASIC FUNCTION

1. BASIC INFORMATION BEFORE OPERATION	32
INITIAL SCREEN	32
TOUCH SCREEN GESTURES.....	34
TOUCH SCREEN OPERATION	35
HOME SCREEN OPERATION	36
ENTERING LETTERS AND NUMBERS/LIST SCREEN OPERATION.....	37
SCREEN ADJUSTMENT	40
2. Bluetooth® SETTINGS	42
REGISTERING/CONNECTING Bluetooth® DEVICE	42
SETTING Bluetooth® DETAILS	45
3. OTHER SETTINGS	53
GENERAL SETTINGS	53
VOICE SETTINGS	59
DRIVER SETTINGS.....	60
MAINTENANCE	61

3 AUDIO SYSTEM

1. BASIC OPERATION 66
 QUICK REFERENCE 66
 SOME BASICS 68

2. RADIO OPERATION 73
 AM/FM RADIO 73
 XM Satellite Radio 83
 INTERNET RADIO 89

3. MEDIA OPERATION 90
 CD 90
 USB MEMORY 93
 iPod 97
 Bluetooth® AUDIO 101
 AUX 106

4. AUDIO REMOTE CONTROLS 108
 STEERING SWITCHES 108

5. SETUP 111
 AUDIO SETTINGS 111

6. TIPS FOR OPERATING THE AUDIO SYSTEM 113
 OPERATING INFORMATION 113

4 VOICE COMMAND SYSTEM

1. VOICE COMMAND SYSTEM OPERATION 124
 VOICE COMMAND SYSTEM 124
 CASUAL SPEECH RECOGNITION 130
 COMMAND LIST 131

5 INFORMATION

1. USEFUL INFORMATION 134
 RECEIVING WEATHER INFORMATION 134
 RECEIVING TRAFFIC MAP INFORMATION 136
 DATA SERVICES SETTINGS 137

6 PERIPHERAL MONITORING SYSTEM

1. REAR VIEW MONITOR SYSTEM 140
 REAR VIEW MONITOR SYSTEM 140
 REAR VIEW MONITOR SYSTEM PRECAUTIONS 144
 THINGS YOU SHOULD KNOW 149

7 PHONE

1. PHONE OPERATION (HANDS-FREE SYSTEM FOR CELLULAR PHONES)..... 152
 QUICK REFERENCE 152
 SOME BASICS 153
 CALLING ON THE Bluetooth® PHONE 156
 RECEIVING ON THE Bluetooth® PHONE 162
 TALKING ON THE Bluetooth® PHONE 163
 Bluetooth® PHONE MESSAGE FUNCTION 166

2. SETUP 171
 PHONE/MESSAGE SETTINGS 171

3. WHAT TO DO IF... 183
 TROUBLESHOOTING 183



TABLE OF CONTENTS

8 NAVIGATION SYSTEM

1. BASIC OPERATION	192
QUICK REFERENCE	192
MAP SCREEN OPERATION	195
MAP SCREEN INFORMATION	201
TRAFFIC INFORMATION	205
2. DESTINATION SEARCH	208
DESTINATION SEARCH SCREEN	208
SEARCH OPERATION	210
STARTING ROUTE GUIDANCE	220
3. ROUTE GUIDANCE	224
ROUTE GUIDANCE SCREEN	224
TYPICAL VOICE GUIDANCE PROMPTS	229
EDITING ROUTE	230
4. MEMORY POINTS	235
MEMORY POINTS SETTINGS	235
5. SETUP	244
DETAILED NAVIGATION SETTINGS	244
TRAFFIC SETTINGS	248
6. TIPS FOR THE NAVIGATION SYSTEM	254
GPS (GLOBAL POSITIONING SYSTEM)	254
MAP DATABASE VERSION AND COVERED AREA	256

9 Entune App Suite

1. Entune App Suite OVERVIEW	260
Entune App Suite SERVICE	260
2. Entune App Suite OPERATION	265
Entune App Suite	265
3. SETUP	272
Entune App Suite SETTINGS	272

INDEX

ALPHABETICAL INDEX	276
---------------------------------	------------

QUICK GUIDE

1 BASIC FUNCTION

- 1. OVERVIEW BUTTONS 12
- 2. “Apps” SCREEN 14
- 3. HOME SCREEN 16
 - STATUS DISPLAY 18

2 QUICK REFERENCE

- 1. “Setup” SCREEN 20

3 NAVIGATION OPERATION

- 1. REGISTERING HOME 22
- 2. REGISTERING PRESET DESTINATIONS 24
- 3. OPERATION FLOW: GUIDING THE ROUTE 26
- 4. SETTING HOME AS THE DESTINATION 27

4 FUNCTION INDEX

- 1. FUNCTION INDEX 28

1. OVERVIEW BUTTONS

► Without navigation function

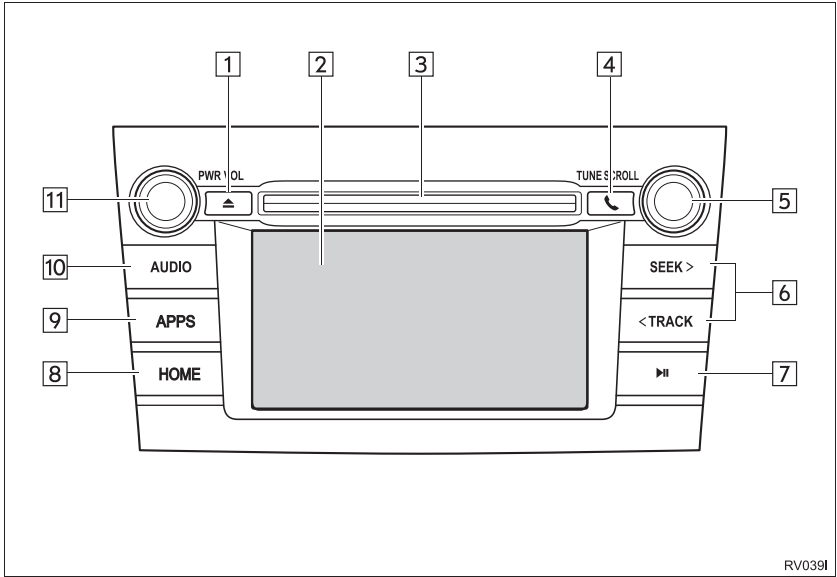

► With navigation function

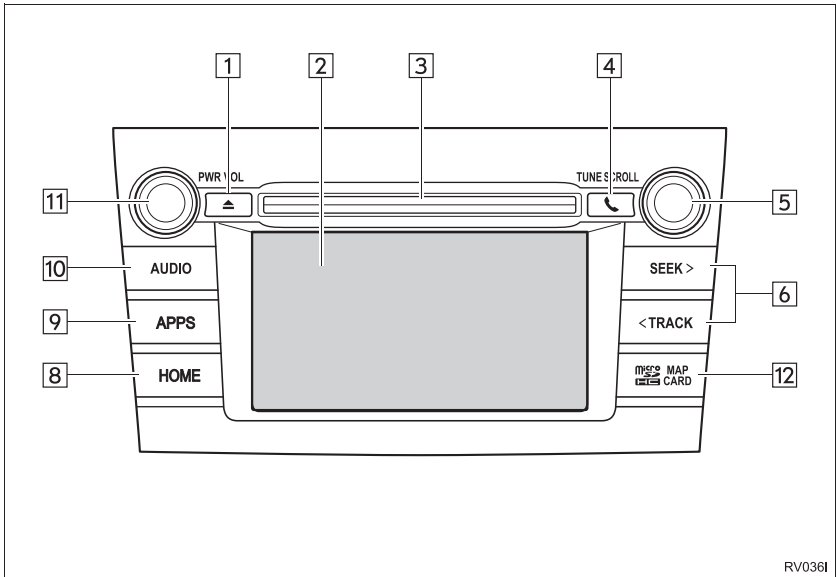



No.	Function	Page
1	Press to eject a disc.	70
2	By touching the screen with your finger, you can control the selected functions.	34, 35
3	Insert a disc into this slot. The CD player turns on immediately.	70
4	Press to access the Bluetooth® hands-free system.	152
5	Turn the “ TUNE SCROLL ” knob to select a radio station or skip to the next or previous track/file.	73, 83, 90, 93, 97, 101
6	Press the “<” or “>” button to seek up or down for a radio station or to access a desired track/file.	73, 83, 90, 93, 97, 101
7	Press to play/pause.	73, 90, 93, 97, 101, 106
8	Press to display the home screen.	16, 36
9	Press to display the “Apps” screen.	14
10	Press to access the audio system. The audio system turns on in the last mode used.	66, 68, 69
11	Press the “ PWR VOL ” knob to turn the system on and off, and turn it to adjust the volume.	68
12	MAP card slot Do not eject the SD card, as doing so may deactivate the navigation system.	257

2. "Apps" SCREEN

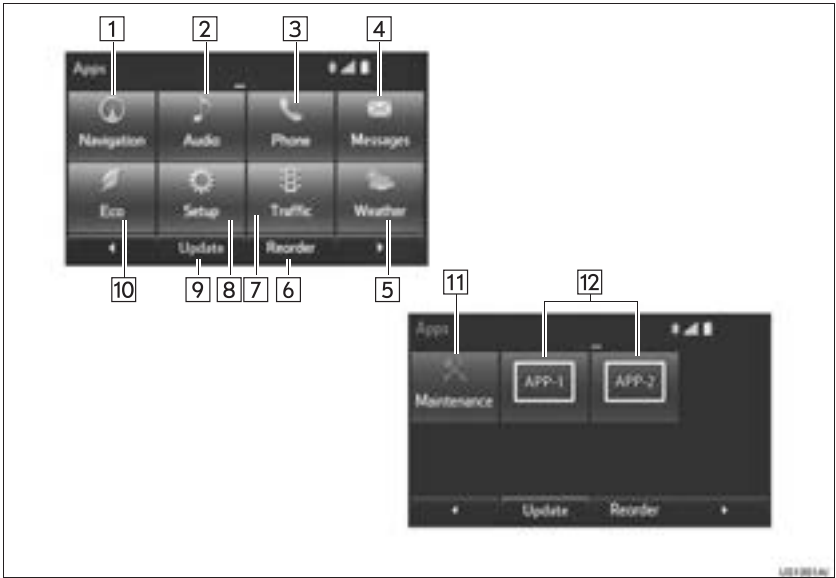
Press the "APPS" button to display the "Apps" screen.



No.	Function	Page
1*	Select to display the map screen.	192
2	Select to display the audio control screen.	66
3	Select to display the hands-free operation screen.	152
4	Select to display the "Message Inbox" screen.	166
5	Select to display weather information.	134
6	Select to reorder the applications. • Select the desired application then  or  to reorder.	267
7	Select to display traffic information.	136, 205
8	Select to display the "Setup" screen.	20
9*	Select to update the applications.	266
10	Select to display the fuel consumption screen.	"Owner's Manual"
11*	Select to display the "Maintenance" screen.	61
12*	Select to display the application screen.	260

*: With navigation function

INFORMATION

- When there are two pages, select  or  to change the page.

3. HOME SCREEN

Press the **“HOME”** button to display the home screen.

The home screen can display multiple information screens, such as the audio system screen, hands-free multiple and navigation screen, simultaneously. When hands-free mode is selected, it is possible to make a call on the home screen if the desired phone number is registered to one of the 4 displayed buttons. In order to register the contact, select and hold the desired button and register the desired contact by obey displayed messages on the screen. (→P.161)

When a screen is selected, the selected screen is switched to a full-screen display. The home screen can be set to either a three-way split screen or a two-way split screen.

For details about setting the home screen: →P.36

► Three-way split screen



▶ Two-way split screen





No.	Function	Page
1	Displays the condition of the Bluetooth® connection	18
2	Select to display the “Setup” screen.	20

STATUS DISPLAY

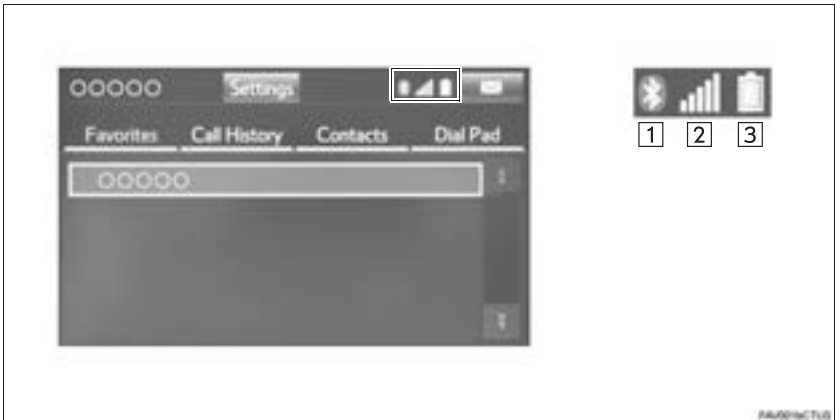
The condition of the Bluetooth® connection, as well as the level of reception and the amount of cellular phone battery charge left, are displayed on the status display.



No.	Indicators	Conditions
1	The condition of the Bluetooth® connection	<p>No connection ↔ Poor (Gray) ↔ Good (Blue)</p> <ul style="list-style-type: none"> An antenna for the Bluetooth® connection is built into the instrument panel. The condition of the Bluetooth® connection may deteriorate and the system may not function when a Bluetooth® phone is used in the following conditions and/or places: The cellular phone is obstructed by certain objects (such as when it is behind the seat or in the glove box or console box). The cellular phone is touching or is covered with metal materials. Leave the Bluetooth® phone in a place where the condition of the Bluetooth® connection is good.
2	The level of reception	<p>Poor ↔ Excellent</p> <ul style="list-style-type: none"> The level of reception does not always correspond with the level displayed on the cellular phone. The level of reception may not be displayed depending on the phone you have. When the cellular phone is out of the service area or in a place inaccessible by radio waves, "No Service" is displayed. "Rm" is displayed when receiving in a roaming area. While roaming, display "Rm" top-left on the icon. The receiving area may not be displayed depending on the type of phone you have.

No.	Indicators	Conditions
3	The amount of battery charge left	<div style="display: flex; justify-content: space-around; align-items: center;">   </div> <p>Empty ←→ Full</p> <ul style="list-style-type: none"> • The amount displayed does not always correspond with the amount displayed on the Bluetooth® device. The amount of battery charge left may not be displayed depending on the type of the Bluetooth® device connected. This system does not have a charging function.

2. QUICK REFERENCE

1. "Setup" SCREEN

The items shown on the "Setup" screen can be set. Press the "APPS" button, then select "Setup" to display the "Setup" screen.

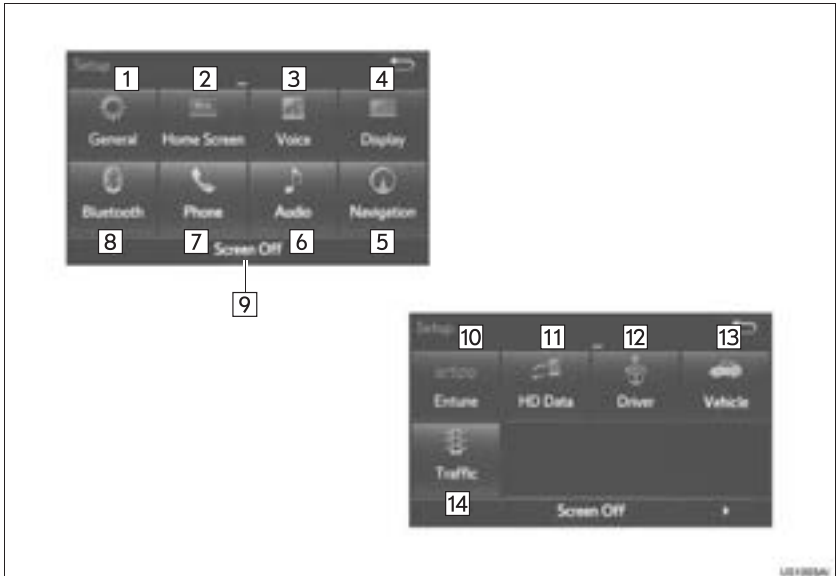

No.	Function	Page
1	Select to change the selected language, operation sound, automatic screen change settings, etc.	53
2	Select to customize the home screen.	36
3	Select to set the voice settings.	59
4	Select to adjust the contrast and brightness of the screens.	40
5 ^{*1}	Select to set memory points (home, preset destinations, address book entries, areas to avoid), navigation details or to delete previous destinations.	235, 244
6	Select to set audio settings.	111
7	Select to set the phone sound, contacts, message settings, etc.	171
8	Select to set Bluetooth [®] phones and Bluetooth [®] audio devices.	45
9	Select to turn the screen off.	—
10 ^{*2}	Select to set Entune App Suite settings.	272
11 ^{*2}	Select to set data services settings.	137
12	Select to link the driver's cellular phone settings. (audio presets, language, etc.)	60
13	Select to set vehicle information.	"Owner's Manual"
14 ^{*2}	Select to set traffic information.	248

*1: With navigation function

*2: With navigation function (only for U.S.A.)

3. NAVIGATION OPERATION

1. REGISTERING HOME*

1 Press the “APPS” button.

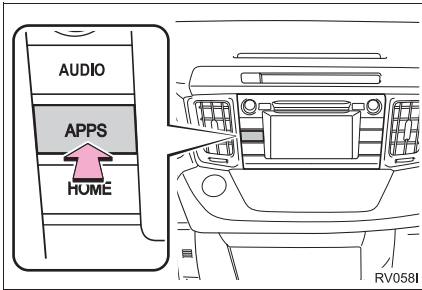

2 Select “Navigation”.



3 Select “Dest.”.



4 Select “Go Home”.



5 Select “Yes”.



6 There are different kinds of methods to search for your home. (→P.208)

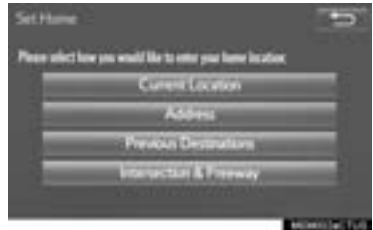

*: With navigation function

7 Select “Enter”.**8 Select “OK”.**

Registration of home is complete.

- ▶ Registering home in a different way
→P.236
- ▶ Editing the name, location, phone number and icon
→P.236
- ▶ Setting home as the destination
→P.211

2. REGISTERING PRESET DESTINATIONS*

1 Press the “APPS” button.

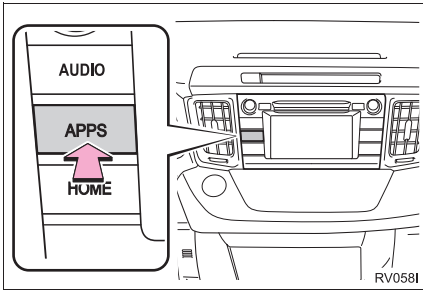

2 Select “Navigation”.



3 Select “Dest.”.



4 Select one of the preset destination buttons.

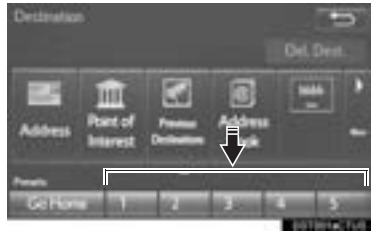

5 Select “Yes”.

6 There are different kinds of methods to search for a destination. (→P.208)

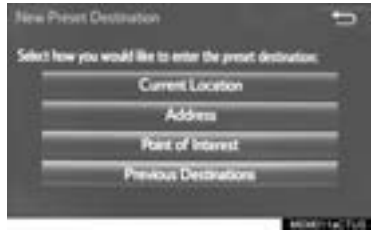

*: With navigation function

7 Select “Enter”.

8 Select a position for this preset destination.



9 Select “OK”.

Registration of preset destinations is complete.

- ▶ Registering preset destinations in a different way
→P.237
- ▶ Editing the name, location, phone number and icon
→P.238
- ▶ Setting preset destinations as the destination
→P.211

3. OPERATION FLOW: GUIDING THE ROUTE*

1 Press the “APPS” button.

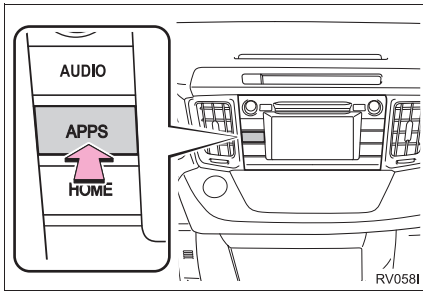

2 Select “Navigation”.



3 Select “Dest.”.



4 There are different kinds of methods to search for a destination. (→P.208)



5 Select “Go”.



6 Select “OK”.

Selecting routes other than the one recommended. (→P.220)

Guidance to the destination is displayed on the screen and can be heard via voice guidance.

*: With navigation function

4. SETTING HOME AS THE DESTINATION*

- 1 Press the “APPS” button.

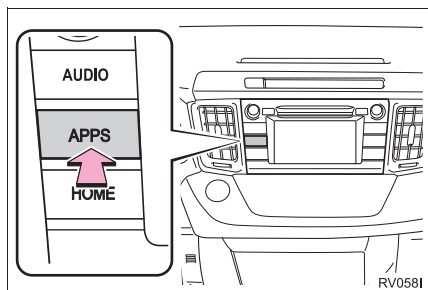

- 2 Select “Navigation”.



- 3 Select “Dest.”.



- 4 Select “Go Home”.



- 5 Select “OK”.

Selecting routes other than the one recommended. (→P.220)

Guidance to the destination is displayed on the screen and can be heard via voice guidance.

*: With navigation function

1. FUNCTION INDEX

▶ Map*

Displaying maps	Page
Viewing the map screen	192
Displaying the current position	195
Viewing the current position vicinity map	199
Changing the scale	195
Changing the map orientation	196
Displaying map information	201
Displaying the estimated travel/arrival time to the destination	224
Selecting the map mode	197
Displaying traffic information	205

Searching for destinations	Page
Searching for the destination	210
Changing the search area	211

▶ Route guidance*

Before starting or during route guidance	Page
Starting route guide	220
Editing the route	230
Viewing the entire route map	225
Pausing guidance	223
Adjusting route guidance volume	59
Deleting the destination	231

Address book	Page
Registering address book entries	239
Marking icons on the map	240

*: With navigation function

► Useful functions

Information	Page
Displaying vehicle maintenance*	61
Hands-free system (for cellular phone)	Page
Registering/connecting Bluetooth® phone	42
Making a call on a Bluetooth® phone	156
Receiving a call on the Bluetooth® phone	162
Voice command system	Page
Operating the system with your voice	124
Peripheral monitoring system	Page
Viewing behind the rear of the vehicle	139

*: With navigation function

BASIC FUNCTION

1 BASIC INFORMATION BEFORE OPERATION

- 1. INITIAL SCREEN 32
- 2. TOUCH SCREEN GESTURES 34
- 3. TOUCH SCREEN OPERATION 35
- 4. HOME SCREEN OPERATION 36
- 5. ENTERING LETTERS AND NUMBERS/LIST SCREEN OPERATION 37
 - ENTERING LETTERS AND NUMBERS 37
 - LIST SCREEN 37
- 6. SCREEN ADJUSTMENT 40

2 Bluetooth® SETTINGS

- 1. REGISTERING/CONNECTING Bluetooth® DEVICE 42
 - REGISTERING A Bluetooth® PHONE FOR THE FIRST TIME 42
 - REGISTERING A Bluetooth® AUDIO PLAYER FOR THE FIRST TIME 43
 - PROFILES 44
- 2. SETTING Bluetooth® DETAILS 45
 - “Bluetooth* Setup” SCREEN 45
 - REGISTERING A Bluetooth® DEVICE 46
 - DELETING A Bluetooth® DEVICE 47
 - CONNECTING A Bluetooth® DEVICE 48
 - EDITING THE Bluetooth® DEVICE INFORMATION 50
 - “System Settings” SCREEN 51

3 OTHER SETTINGS

- 1. GENERAL SETTINGS 53
 - GENERAL SETTINGS SCREEN 53
- 2. VOICE SETTINGS 59
 - VOICE SETTINGS SCREEN 59
- 3. DRIVER SETTINGS 60
 - MANUALLY SELECT LINKED SETTINGS 60
- 4. MAINTENANCE 61

*: Bluetooth is a registered trademark of Bluetooth SIG, Inc.

1. INITIAL SCREEN

1 When the engine switch is in the “ACC” or “ON” position, the initial screen will be displayed and the system will begin operating. (Vehicles without a smart key system)

When the engine switch is in ACCESSORY or IGNITION ON mode, the initial screen will be displayed and the system will begin operating. (Vehicles with a smart key system)



- Images shown on the initial screen can be changed to suit individual preferences. (→P.56)

- After a few seconds, the “Caution” screen will be displayed.
- After about 5 seconds, the “Caution” screen automatically switches to the next screen.

CAUTION

- When the vehicle is stopped with the engine running, always apply the parking brake for safety.

MAINTENANCE INFORMATION*

This system reminds users when to replace certain parts or components and shows dealer information (if registered) on the screen.

When the vehicle reaches a previously set driving distance or date specified for a scheduled maintenance check, the “Maintenance Reminder” screen will be displayed when the system is turned on.



- The screen goes off if the screen is not operated for several seconds.
- To prevent the screen from being displayed again, select “Do Not Tell Me Again”.
- To register maintenance information: →P.61
- If  is selected, the registered phone number can be called.

*: With navigation function

RESTARTING THE SYSTEM

When system response is extremely slow, the system can be restarted.

- 1 Press and hold the **“PWR VOL”** knob for 3 seconds or more.

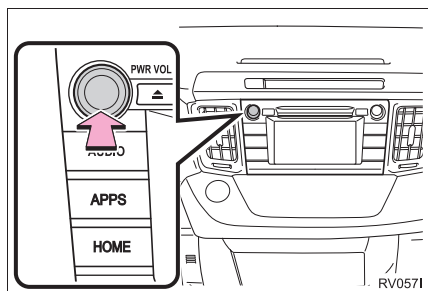

2. TOUCH SCREEN GESTURES

Operations are performed by touching the touch screen directly with your finger.

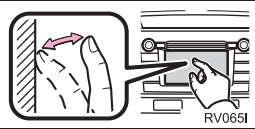
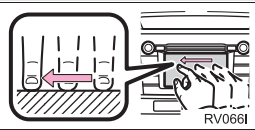
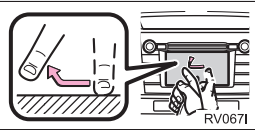
Operation method	Outline	Main use
	<p>Touch Quickly touch and release once.</p>	<p>Changing and selecting various settings</p>
	<p>Drag^{*1} Touch the screen with your finger, and move the screen to the desired position.</p>	<ul style="list-style-type: none"> • Scrolling the lists • Scrolling the map screen^{*2}
	<p>Flick^{*1} Quickly move the screen by flicking with your finger.</p>	<ul style="list-style-type: none"> • Scrolling the main screen page • Scrolling the map screen^{*2}

*1: The above operations may not be performed on all screens.

*2: With navigation function

INFORMATION

- Flick operations may not be performed smoothly in high altitudes.

3. TOUCH SCREEN OPERATION

This system is operated mainly by the buttons on the screen. (Referred to as screen buttons in this manual.)

- When a screen button is touched, a beep sounds. (To set the beep sound, see page 53.)



NOTICE

- To prevent damaging the screen, lightly touch the screen buttons with your finger.
- Do not use objects other than your finger to touch the screen.
- Wipe off fingerprints using a glass cleaning cloth. Do not use chemical cleaners to clean the screen, as they may damage the touch screen.

INFORMATION

- If the system does not respond to touching a screen button, move your finger away from the screen and then touch it again.
- Dimmed screen buttons cannot be operated.
- The displayed image may become darker and moving images may be slightly distorted when the screen is cold.
- In extremely cold conditions, the map may not be displayed and the data input by a user may be deleted. Also, the screen buttons may be harder than usual to depress.
- When you look at the screen through polarized material such as polarized sunglasses, the screen may be dark and hard to see. If so, look at the screen from different angles, adjust the screen settings on the "Display Settings" screen or take off your sunglasses.

4. HOME SCREEN OPERATION

The home screen can display multiple information screens, such as the audio system screen and hands-free screen, simultaneously.

- 1 Press the “HOME” button.
- 2 “Home” screen is displayed.



- When a screen is selected, the selected screen will change to a full-screen display.

CUSTOMIZING THE HOME SCREEN

The display items/area on the home screen can be changed.

- 1 Select  .



- 2 Select “Home Screen”.
- Select “Two Panel” or “Three Panel”.
- 3 Select the desired area.
- 4 Select the desired item.
- 5 Select “OK”.

INFORMATION

- When the selected item is already being displayed and another area is selected for that item, the item that it is replacing will be displayed in the original item's location.

5. ENTERING LETTERS AND NUMBERS/LIST SCREEN OPERATION

When searching by an address, name, etc., or entering data, letters and numbers can be entered via the screen.

ENTERING LETTERS AND NUMBERS

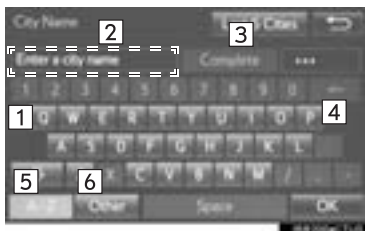

No.	Function
1	Select to enter desired characters.
2	Text field. Entered character(s) will be displayed.
3	During entering character(s), when there is only one available option for the next character(s), the next character(s) will be displayed in gray text in the text field automatically. Gray text is entered by selecting this button.
4	Select to erase one character. Select and hold to continue erasing characters.
5	Select to display the alphabet keys.
6	Select to display other symbols.

- On certain letter entry screens, letters can be entered in upper or lower case.

 : Select to enter in lower case.

 : Select to enter in upper case.

- Keyboard layout can be changed. (→P.53)

LIST SCREEN

The list screen may be displayed after entering characters.

DISPLAYING THE LIST

- 1 Enter characters and select “OK”.



- Matching items from the database are listed even if the entered address or name is incomplete.
- The list will be displayed automatically if the maximum number of characters is entered or matching items can be displayed on a single list screen.

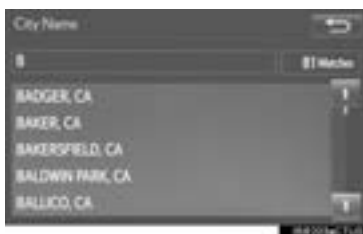

INFORMATION

- The number of matching items is shown on the right side of the screen. If the number of matching items is more than 999, the system displays “***” on the screen.

SELECTING ALL ITEMS

Some lists contain “**Select All**”. If “**Select All**” is selected, it is possible to select all items.

1 Select “**Select All**”.

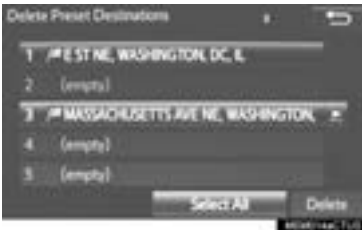

“**Unselect All**”: Unselect all items in the list.

LIST SCREEN OPERATION

When a list is displayed, use the appropriate screen button to scroll through the list.



Icon	Function
	Select to skip to the next or previous page.
	Select and hold or to scroll through the displayed list.
	This indicates the displayed screen's position.
	If appears to the right of an item name, the complete name is too long to display.
	Select to scroll to the end of the name.
	Select to move to the beginning of the name.

SORTING

The order of a list displayed on the screen can be sorted in the order of distance from the current location, date, category, etc.

- 1 Select **"Sort"**.



- 2 Select the desired sorting criteria.

CHARACTER JUMP BUTTONS IN LISTS

Some lists contain character screen buttons, "ABC", "DEF" etc., which allow a direct jump to list entries that begin with the same letter as the character screen button.

- 1 Select the desired character jump buttons.



INFORMATION

- Every time the same character screen button is selected, the list starting with the subsequent character is displayed.

6. SCREEN ADJUSTMENT

The contrast and brightness of the screen display and the image of the camera display can be adjusted. The screen can also be changed to either day or night mode.

- 1 Press the “APPS” button.

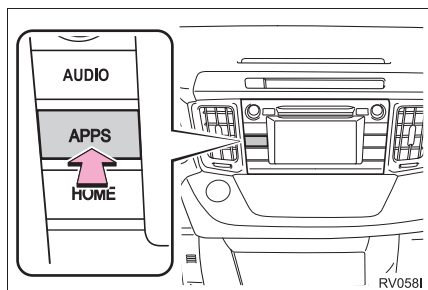

- 2 Select “Setup”.
- 3 Select “Display”.
- 4 Select the items to be set.



No.	Function	Page
1	Select to adjust the screen display.	41
2	Select to adjust the camera display.	
3	Select to turn day mode on/off.	40

INFORMATION

- When the screen is viewed through polarized sunglasses, a rainbow pattern may appear on the screen due to optical characteristics of the screen. If this is disturbing, please operate the screen without polarized sunglasses.

CHANGING BETWEEN DAY AND NIGHT MODE

Depending on the position of the headlight switch, the screen changes to day or night mode. This feature is available when the headlight is switched on.

- 1 Select “Day Mode”.

INFORMATION

- If the screen is set to day mode with the headlight switch turned on, this condition is memorized even with the engine turned off.

ADJUSTING THE CONTRAST/ BRIGHTNESS

The contrast and brightness of the screen can be adjusted according to the brightness of your surroundings.

- 1 Select “**General**” or “**Camera**”.
- 2 Select the desired item.

► General



► Camera



Screen button	Function
“Brightness” “+”	Select to brighten the screen.
“Brightness” “-”	Select to darken the screen.
“Contrast” “+”	Select to strengthen the contrast of the screen.
“Contrast” “-”	Select to weaken the contrast of the screen.

- 3 Select “**OK**”.

1. REGISTERING/CONNECTING Bluetooth® DEVICE

REGISTERING A Bluetooth® PHONE FOR THE FIRST TIME

To use the hands-free system, it is necessary to register a Bluetooth® phone with the system.

Once the phone has been registered, it is possible to use the hands-free system.

This operation cannot be performed while driving.

For details about registering a Bluetooth® device: →P.46



1 Turn the Bluetooth® connection setting of your cellular phone on.

- This function is not available when Bluetooth® connection setting of your cellular phone is set to off.

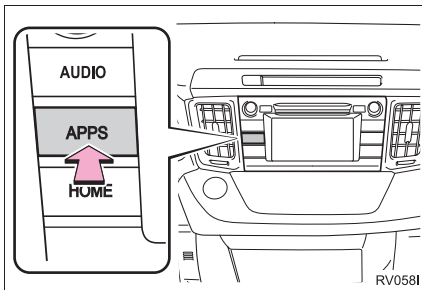
2 Press the “APPS” button.



3 Select “Phone”.

- Operations up to this point can also be performed by pressing the  switch on the steering wheel or  switch on the instrument panel.

4 Select “Yes” to register a phone.

5 When this screen is displayed, search for the device name displayed on this screen on the screen of your Bluetooth® device.



- For details about operating the Bluetooth® device, see the manual that comes with it.
- To cancel the registration, select “Cancel”.

6 Register the Bluetooth® device using your Bluetooth® device.

- A PIN-code is not required for SSP (Secure Simple Pairing) compatible Bluetooth® devices. Depending on the type of Bluetooth® device being connected, a message confirming registration may be displayed on the Bluetooth® device's screen. Respond and operate the Bluetooth® device according to the confirmation message.

7 Check that the screen is displayed when registration is complete.

- The system waits for connection requests coming from the registered device.
- At this stage, the Bluetooth® functions are not yet available.

8 Select “OK” when the connection status changes from “Connecting...” to “Connected”.

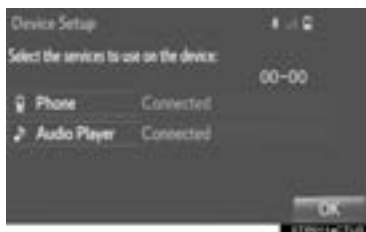

- If an error message is displayed, follow the guidance on the screen to try again.

REGISTERING A Bluetooth® AUDIO PLAYER FOR THE FIRST TIME

To use the Bluetooth® Audio, it is necessary to register an audio player with the system.

Once the player has been registered, it is possible to use the Bluetooth® Audio.

This operation cannot be performed while driving.

For details about registering a Bluetooth® device: →P.46

1 Turn the Bluetooth® connection setting of your audio player on.

- This function is not available when the Bluetooth® connection setting of your audio player is set to off.

2 Press the “AUDIO” button.

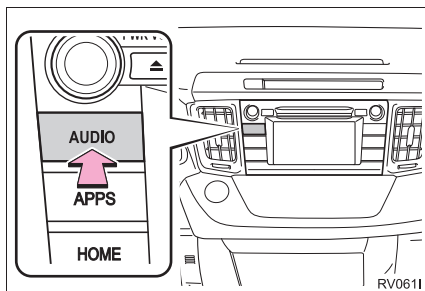

3 Select “Source” on the audio screen or press “AUDIO” button again.

4 Select “ Audio”.

5 Select “Yes” to register an audio player.

6 Follow the steps in “REGISTERING A Bluetooth® DEVICE” from “STEP 2”. (→P.46)

PROFILES

This system supports the following services.

Bluetooth® Device	Spec.	Function	Requirements	Recommendations
Bluetooth® Phone/ Bluetooth® Audio Player	Bluetooth® Specification	Registering a Bluetooth® device	Ver. 2.0	Ver. 3.0 +EDR
Bluetooth® Device	Profile	Function	Requirements	Recommendations
Bluetooth® Phone	HFP (Hands-Free Profile)	Hands-free system	Ver. 1.0	Ver. 1.6
	OPP (Object Push Profile)	Transferring the contacts	Ver. 1.1	Ver. 1.2
	PBAP (Phone Book Access profile)		Ver. 1.0	Ver. 1.1
	MAP (Message Access Profile)	Bluetooth® phone message	—	Ver. 1.0
	SPP (Serial Port Profile)	Entune App Suite*	—	Ver. 1.1
Bluetooth® Audio Player	A2DP (Advanced Audio Distribution Profile)	Bluetooth® audio system	Ver. 1.0	Ver. 1.2
	AVRCP (Audio/Video Remote Control Profile)		Ver. 1.0	Ver. 1.4

*: With navigation function

INFORMATION

- If your cellular phone does not support HFP, registering the Bluetooth® phone or using OPP, PBAP, MAP or SPP profiles individually will not be possible.
- If the connected Bluetooth® device version is older than recommended or incompatible, the Bluetooth® device function may not work properly.
- Refer to <http://www.toyota.com/entune/> to find approved Bluetooth® phones for this system.



Bluetooth is a registered trademark of Bluetooth SIG, Inc.

2. SETTING Bluetooth® DETAILS

- 1 Press the “APPS” button.

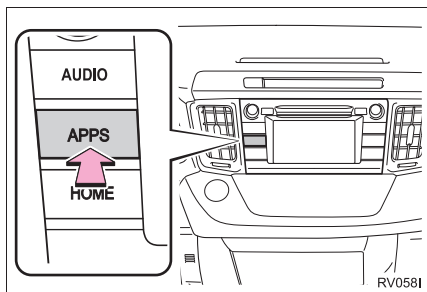

- 2 Select “Setup”.
- 3 Select “Bluetooth*”.
- 4 Select the desired item to be set.



“Bluetooth* Setup” SCREEN



Function	Page
Registering a Bluetooth® device	46
Deleting a Bluetooth® device	47
Connecting a Bluetooth® device	48
Editing the Bluetooth® device information	50
Bluetooth® system settings	51

*: Bluetooth is a registered trademark of Bluetooth SIG, Inc.

DISPLAYING THE “Bluetooth* Setup” SCREEN IN A DIFFERENT WAY

► From the phone/message settings screen

- 1 Press the “**APPS**” button.
- 2 Select “**Setup**”.
- 3 Select “**Phone**”.
- 4 Select “**Connect Phone**”.

► From the status display

- 1 Select status display area on the screen.

REGISTERING A Bluetooth® DEVICE

Up to 5 Bluetooth® devices can be registered.

Bluetooth® compatible phones (HFP) and audio players (AVP) can be registered simultaneously.

This operation cannot be performed while driving.

- 1 Display the “Bluetooth* Setup” screen. (→P.45)
- 2 Select “**Add**”.
 - When another Bluetooth® device is connected
 - To disconnect the Bluetooth® device, select “**Yes**”.
 - When 5 Bluetooth® devices have already been registered
 - A registered device needs to be replaced. Select “**Yes**”, and select the device to be replaced.
- 3 When this screen is displayed, search for the device name displayed on this screen on the screen of your Bluetooth® device.



*: Bluetooth is a registered trademark of Bluetooth SIG, Inc.

- For details about operating the Bluetooth® device, see the manual that comes with it.
 - To cancel the registration, select “**Cancel**”.
- 4 Register the Bluetooth® device using your Bluetooth® device.
 - A PIN-code is not required for SSP (Secure Simple Pairing) compatible Bluetooth® devices. Depending on the type of Bluetooth® device being connected, a message confirming registration may be displayed on the Bluetooth® device’s screen. Respond and operate the Bluetooth® device according to the confirmation message.
 - 5 Check that the screen is displayed when registration is complete.
 - The system waits for connection requests coming from the registered device.
 - At this stage, the Bluetooth® functions are not yet available.
 - 6 Select “**OK**” when the connection status changes from “Connection waiting...” to “Connected”.

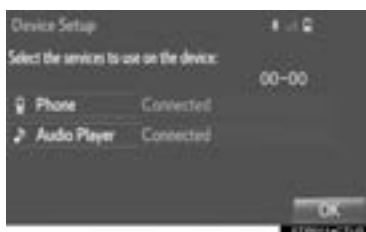

- If an error message is displayed, follow the guidance on the screen to try again.

DELETING A Bluetooth® DEVICE

- 1 Display the “Bluetooth* Setup” screen. (→P.45)
- 2 Select “**Remove**”.
- 3 Select the desired device.



- 4 Select “**Yes**” when the confirmation screen appears.
- 5 Check that a confirmation screen is displayed when the operation is complete.

INFORMATION

- When deleting a Bluetooth® phone, the contact data will be deleted at the same time.

*: Bluetooth is a registered trademark of Bluetooth SIG, Inc.

CONNECTING A Bluetooth® DEVICE

Up to 5 Bluetooth® devices (Phones (HFP) and audio players (AVP)) can be registered.

If more than 1 Bluetooth® device has been registered, select which device to connect to.

1 Display the “Bluetooth* Setup” screen.
(→P.45)

2 Select the device to be connected.



● Supported profile icons will be displayed.

 : Phone

 : Audio player

 : Phone/Entune App Suite service
(With navigation function)

● Supported profile icons for currently connected devices will illuminate.

● Dimmed icons can be selected to connect to the phone/audio function directly.

● If the desired Bluetooth® device is not on the list, select “**Add**” to register the device. (→P.46)

*: Bluetooth is a registered trademark of Bluetooth SIG, Inc.

3 Select the desired connection.

▶ When another Bluetooth® device is connected

● To disconnect the Bluetooth® device, select “**Yes**”.

4 Check that a confirmation screen is displayed when the connection is complete.

● If an error message is displayed, follow the guidance on the screen to try again.

INFORMATION

● It may take time if the device connection is carried out during Bluetooth® audio playback.

● Depending on the type of Bluetooth® device being connected, it may be necessary to perform additional steps on the device.

■ AUTO CONNECTION MODE

To turn auto connection mode on, set “Bluetooth* Power” to on. (→P.51)
Leave the Bluetooth® device in a location where the connection can be established.

- ▶ Vehicles without a smart key system
 - When the engine switch is in the “ACC” or “ON” position, the system searches for a nearby registered device.
 - The system will connect with the registered device that was last connected, if it is nearby.
- ▶ Vehicles with a smart key system
 - When the engine switch is in ACCESSORY or IGNITION ON mode, the system searches for a nearby registered device.
 - The system will connect with the registered device that was last connected, if it is nearby.

■ CONNECTING MANUALLY

When the auto connection has failed or “Bluetooth* Power” is turned off, it is necessary to connect Bluetooth® manually.

- 1 Press the “APPS” button and select “Setup”.
- 2 Select “Bluetooth*”.
- 3 Follow the steps in “CONNECTING A Bluetooth® DEVICE” from “STEP 2”. (→P.48)

*: Bluetooth is a registered trademark of Bluetooth SIG, Inc.

■ RECONNECTING THE Bluetooth® PHONE

If a Bluetooth® phone is disconnected due to poor reception from the Bluetooth® network when the engine switch is in the following, the system automatically reconnects the Bluetooth® phone.

- ▶ Vehicles without a smart key system
The engine switch is turned to the “ACC” or “ON” position.
- ▶ Vehicles with a smart key system
The engine switch is turned to ACCESSORY or IGNITION ON mode.

- If a Bluetooth® phone is disconnected on purpose, such as turning it off, this does not happen. Reconnect the Bluetooth® phone manually.

EDITING THE Bluetooth® DEVICE INFORMATION

The Bluetooth® device's information can be displayed on the screen. The displayed information can be edited.

- 1 Display the "Bluetooth* Setup" screen. (→P.45)
- 2 Select the desired device to be edited.
- 3 Select "Device Info".

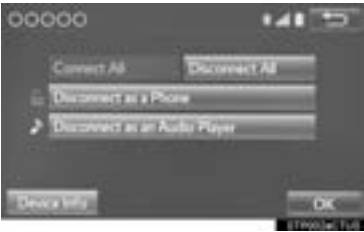

- 4 Confirm and change the Bluetooth® device information.

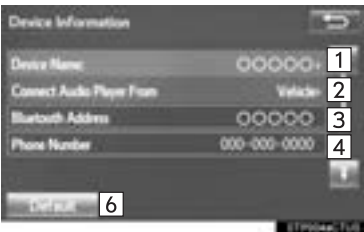

No.	Information
1	The name of the Bluetooth® device. Can be changed to a desired name. (→P.51)
2	Select to set the Bluetooth® audio player connection method. (→P.51)
3	Device address is unique to the device and cannot be changed.
4	Phone number of the Bluetooth® phone.
5	Compatibility profile of the Bluetooth® device.
6	Select to reset all setup items.

INFORMATION

- If 2 Bluetooth® devices have been registered with the same device name, the devices can be distinguished referring to the device's address.
- Depending on the type of phone, some information may not be displayed.

*: Bluetooth is a registered trademark of Bluetooth SIG, Inc.

CHANGING A DEVICE NAME

- 1 Select **“Device Name”**.
- 2 Enter the name and select **“OK”**.

INFORMATION

- Even if the device name is changed, the name registered in your Bluetooth® device does not change.

SETTING AUDIO PLAYER CONNECTION METHOD

- 1 Select **“Connect Audio Player From”**.

2 Select the desired connection method.
“Vehicle”: Select to connect the audio system to the audio player.

“Device”: Select to connect the audio player to the audio system.

- Depending on the audio player, the “Vehicle” or “Device” connection method may be best. As such, refer to the manual that comes with the audio player.
- To reset the connection method, select **“Default”**.

“System Settings” SCREEN

The Bluetooth® settings can be confirmed and changed.

- 1 Display the “Bluetooth* Setup” screen. (→P.45)
- 2 Select **“System Settings”**.
- 3 Select the desired item to be set.

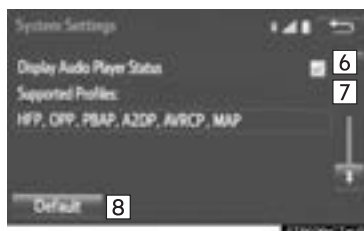

*: Bluetooth is a registered trademark of Bluetooth SIG, Inc.

No.	Information	Page
1	Select to set Bluetooth® connection on/off.	52
2	Displays system name. Can be changed to a desired name.	52
3	PIN-code used when the Bluetooth® device was registered. Can be changed to a desired code.	52
4	Device address is unique to the device and cannot be changed.	—
5	Select to set the phone connection status display on/off.	—
6	Select to set the connection status display of the audio player on/off.	—
7	Compatibility profile of the system device.	—
8	Select to reset all setup items.	—

CHANGING “Bluetooth* Power”

1 Select “Bluetooth* Power”.

When “Bluetooth* Power” is on:

► Vehicles without a smart key system
The Bluetooth® device is automatically connected when the engine switch is turned to the “ACC” or “ON” position.

► Vehicles with a smart key system
The Bluetooth® device is automatically connected when the engine switch is turned to ACCESSORY or IGNITION ON mode.

When “Bluetooth* Power” is off:

The Bluetooth® device is disconnected, and the system will not connect to it next time.

INFORMATION

- While driving, the auto connection state can be changed from off to on, but cannot be changed from on to off.

EDITING THE Bluetooth* NAME

1 Select “Bluetooth* Name”.

2 Enter a name and select “OK”.

EDITING THE PIN-CODE

1 Select “Bluetooth* PIN”.

2 Enter a PIN-code and select “OK”.

*: Bluetooth is a registered trademark of Bluetooth SIG, Inc.

1. GENERAL SETTINGS

Settings are available for system time, operation sounds, etc.

- 1 Press the “APPS” button.

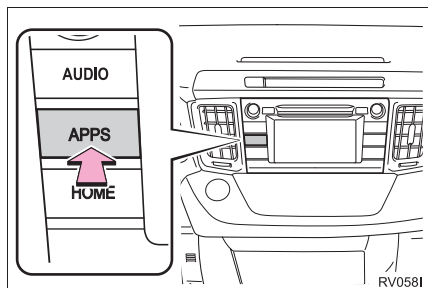

- 2 Select “Setup”.
- 3 Select “General”.
- 4 Select the items to be set.

GENERAL SETTINGS SCREEN



No.	Function
1	Select to change the time zone and set the daylight saving time on/off. (→P.55)
2	Select to change the language.
3*	Select to change the unit of measure for distance.
4	Select to change the unit of temperature.
5	Select to set the sound beeps on/off.
6	Select to change the screen button color.
7	Select to change the keyboard layout.
8	Select to set automatic screen changes from the audio control screen to the home screen to on/off. When set to on, the screen will automatically return to the home screen from the audio control screen after 20 seconds.

No.	Function
9	Select to set the animations on/off.
10	Select to customize the startup image. (→P.56)
11	Select to customize the screen off image. (→P.57)
12	Select to delete personal data. (→P.58)
13	Select to update software versions. For details, contact your Toyota dealer.
14	Select to update "Gracenote" database versions. For details, contact your Toyota dealer.
15	Select to display the software information. Notices related to third party software used in this product are en-listed. (This includes instructions for obtaining such software, where applicable.)
16	Select to reset all setup items.

*: With navigation function

SYSTEM TIME SETTINGS

Used for changing time zones and the on/off settings of daylight saving time.

- 1 Display the “General Settings” screen. (→P.53)
- 2 Select “**System Time**”.
- 3 Select the items to be set.

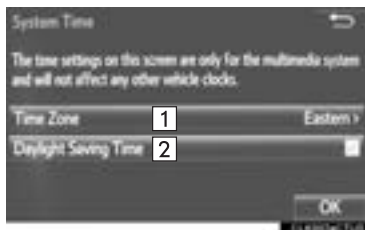

No.	Function
1	Select to change the time zone. (→P.55)
2	Select to set daylight saving time on/off.

- 4 Select “**OK**”.

SETTING THE TIME ZONE

- 1 Select “**Time Zone**”.
- 2 Select the desired time zone.



CUSTOMIZING THE STARTUP AND SCREEN OFF IMAGES

An image can be copied from a USB memory and used as the startup and screen off images.

▶ Vehicles without a smart key system

When the engine switch is in the “ACC” or “ON” position, the initial screen will be displayed. (→P.32)

▶ Vehicles with a smart key system

When the engine switch is in ACCESSORY or IGNITION ON mode, the initial screen will be displayed. (→P.32)

TRANSFERRING IMAGES

- 1 Open the cover and connect a USB memory.

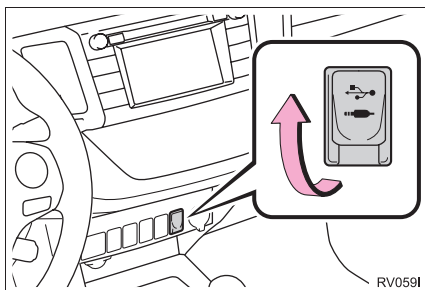

- Turn on the power of the USB memory if it is not turned on.
- 2 Press the “**APPS**” button.
 - 3 Select “**Setup**”.
 - 4 Select “**General**”.
 - 5 Select “**Customize Startup Image**” or “**Customize Screen Off Image**”.
 - 6 Select “**Transfer**”.
 - 7 Select “**Yes**”.

INFORMATION

- When saving the images to a USB, name the folder that the startup image is saved to “StartupImage” and name the folder that the screen off image is saved to “DisplayOffImage”. If these folder names are not used, the system cannot download the images. (The folder names are case sensitive.)
- The compatible file extensions are JPG and JPEG.
- Image files of 5 MB or less can be transferred.
- Up to 3 images can be downloaded.
- Files with non-ASCII filenames can not be downloaded.

SETTING THE STARTUP IMAGES

- 1 Display the “General Settings” screen. (→P.53)
- 2 Select “**Customize Startup Image**”.
- 3 Select the desired image.



- 4 Select “**OK**”.

SETTINGS THE SCREEN OFF IMAGES

- 1 Display the “General Settings” screen. (→P.53)
- 2 Select “**Customize Screen Off Image**”.
- 3 Select the desired image.



- 4 Select “**OK**”.

DELETING TRANSFERRED IMAGES

- 1 Display the “General Settings” screen. (→P.53)
- 2 Select “**Customize Startup Image**” or “**Customize Screen Off Image**”.
- 3 Select “**Delete All**”.



- 4 Select “**Yes**”.

DELETING PERSONAL DATA

- 1 Display the “General Settings” screen. (→P.53)
- 2 Select “**Delete Personal Data**”.
- 3 Select “**Delete**”.



- 4 Select “**Yes**” when the confirmation screen appears.
 - Registered or changed personal settings will be deleted or returned to their default conditions.
 - For example:
 - General settings
 - Navigation settings*
 - Audio settings
 - Phone settings
- *: With navigation function

NOTICE

- With navigation function: Make sure the map SD card is inserted when deleting personal data. The personal data cannot be deleted when the map SD card is removed.
 - ▶ Vehicles without a smart key system
To delete the data, after inserting the map SD card, turn the engine switch to “LOCK” position and then turn the engine switch to “ACC” or “ON” position.
 - ▶ Vehicles with a smart key system
To delete the data, after inserting the map SD card, turn the engine switch OFF and then turn the engine switch to ACCESSORY or IGNITION ON mode.

2. VOICE SETTINGS

Voice volume, etc. can be set.

- 1 Press the “APPS” button.

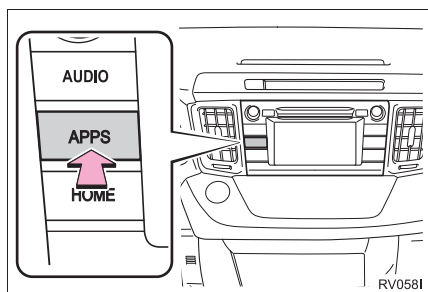

- 2 Select “Setup”.
- 3 Select “Voice”.
- 4 Select the items to be set.

INFORMATION

- “Voice Settings” screen can also be displayed from the voice recognition top screen. (→P.126)

VOICE SETTINGS SCREEN

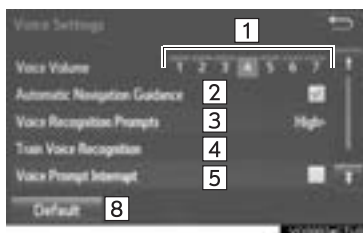

No.	Function
1	Select to adjust the volume of voice guidance.
2*	Select to set the voice guidance during route guidance on/off.
3	Select to set the voice recognition prompts.
4	Select to train voice recognition. The voice command system adapt the user accent.
5	Select to set the voice prompt interrupt on/off.
6*	Select to set the web search engine. The search engines are Entune App Suite applications. (→P.265)
7	Select to set the voice recognition tutorial.
8	Select to reset all setup items.

*: With navigation function

3. DRIVER SETTINGS

The driver settings feature will allow the system to link some preferences (such as audio presets, button colors, language, etc.) to a paired Bluetooth® phone.

- 1 Press the “**APPS**” button.

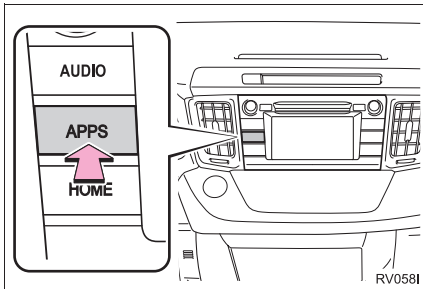

- 2 Select “**Setup**”.
- 3 Select “**Driver**”.
- 4 Select “**Enable this Feature**”.

MANUALLY SELECT LINKED SETTINGS

- 1 Display the driver settings screen. (→P.60)
- 2 Select “**Manually Select Linked Settings**”.

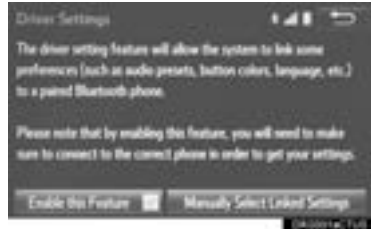

- 3 Select the desired phone.
 - After a few seconds, loaded screen automatically switches to the home screen.

4. MAINTENANCE*

When this system is turned on, the "Maintenance Reminder" screen displays when it is time to replace a part or certain components. (→P.32)

- 1 Press the "APPS" button.

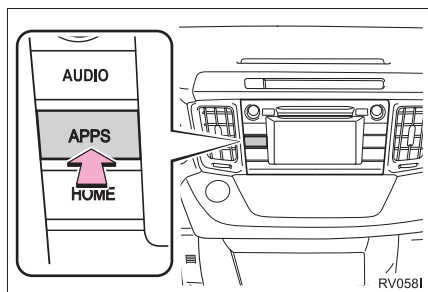

- 2 Select "Maintenance".

- 3 Select the desired item.

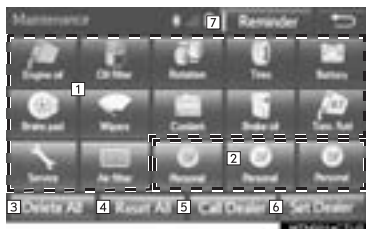

No.	Function
1	Select to set the condition of parts or components.
2	Select to add new information items separately from provided ones.
3	Select to cancel all conditions which have been entered.
4	Select to reset the item which have expired conditions.
5	Select to call the registered dealer.
6	Select to register/edit dealer information. (→P.62)
7	When set to on, the indicator will illuminate. The system is set to give maintenance information with the "Maintenance Reminder" screen. (→P.32)

INFORMATION

- When the vehicle needs to be serviced, the screen button color will change to orange.

*: With navigation function

MAINTENANCE INFORMATION SETTING

- 1 Select the desired part or component screen button.
 - When the vehicle needs to be serviced, the screen button color will change to orange.
- 2 Set the conditions.

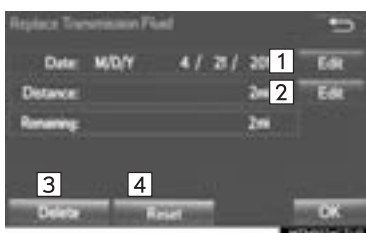

No.	Function
1	Select to enter the next maintenance date.
2	Select to enter the driving distance until the next maintenance check.
3	Select to cancel the conditions which have been entered.
4	Select to reset the conditions which have expired.

- 3 Select “OK” after entering the conditions.

INFORMATION

- For scheduled maintenance information, refer to “Scheduled Maintenance Guide” or “Owner’s Manual Supplement”.
- Depending on driving or road conditions, the actual date and distance that maintenance should be performed may differ from the stored date and distance in the system.

DEALER SETTING

Dealer information can be registered in the system. With dealer information registered, route guidance to the dealer is available.

- 1 Select “Set Dealer”.
- 2 Select the desired item to search for the location. (→P.208)



- The editing dealer screen appears after setting the location.

3 Select the items to be edited.



No.	Function	Page
1	Select to enter the name of a dealer.	63
2	Select to enter the name of a dealer member.	63
3	Select to set the location.	63
4	Select to enter the phone number.	63
5	Select to delete the dealer information displayed on the screen.	—
6	Select to set the displayed dealer as a destination.	220

■ EDITING DEALER OR CONTACT NAME

- 1 Select “**Edit**” next to “Dealer” or “Contact”.
- 2 Enter the name and select “**OK**”.

■ EDITING THE LOCATION

- 1 Select “**Edit**” next to “Location”.
- 2 Scroll the map to the desired point (→P.200) and select “**OK**”.

■ EDITING PHONE NUMBER

- 1 Select “**Edit**” next to “Phone #”.
- 2 Enter the phone number and select “**OK**”.

1 BASIC OPERATION

1. QUICK REFERENCE	66
2. SOME BASICS	68
TURNING THE SYSTEM ON AND OFF	68
SELECTING AN AUDIO SOURCE	69
DISC SLOT	70
USB/AUX PORT	70
SOUND SETTINGS	71
VOICE COMMAND SYSTEM	72

2 RADIO OPERATION

1. AM/FM RADIO	73
OVERVIEW	73
PRESETTING A STATION	76
SELECTING A STATION FROM THE LIST	76
CACHING A RADIO PROGRAM	77
RADIO BROADCAST DATA SYSTEM	78
TRAFFIC ANNOUNCEMENT (FM RADIO)	79
USING HD Radio™ TECHNOLOGY	79
AVAILABLE HD Radio™ TECHNOLOGY	80
TROUBLESHOOTING GUIDE	82
2. XM Satellite Radio	83
OVERVIEW	83
HOW TO SUBSCRIBE TO AN XM Satellite Radio	85
DISPLAYING THE RADIO ID	87
PRESETTING A CHANNEL	87
SELECTING A CHANNEL FROM THE LIST	87
IF THE SATELLITE RADIO TUNER MALFUNCTIONS	88
3. INTERNET RADIO	89
LISTENING TO INTERNET RADIO	89

3

AUDIO SYSTEM

3 MEDIA OPERATION

1. CD	90
OVERVIEW	90
PLAYING AN AUDIO CD	92
PLAYING AN MP3/WMA/AAC DISC.....	92
2. USB MEMORY	93
OVERVIEW	93
PLAYING A USB AUDIO	96
3. iPod	97
OVERVIEW	97
iPod AUDIO	100
iPod VIDEO	100
4. Bluetooth® AUDIO	101
OVERVIEW	101
CONNECTING A Bluetooth® DEVICE.....	105
LISTENING TO Bluetooth® AUDIO.....	105
5. AUX	106
OVERVIEW	106

4 AUDIO REMOTE CONTROLS

1. STEERING SWITCHES	108
-----------------------------------	------------

5 SETUP

1. AUDIO SETTINGS	111
AUDIO SETTINGS SCREEN.....	111

6 TIPS FOR OPERATING THE AUDIO SYSTEM

1. OPERATING INFORMATION	113
RADIO.....	113
CD PLAYER AND DISC	114
iPod.....	116
FILE INFORMATION	117
TERMS	120
ERROR MESSAGES	121

1. QUICK REFERENCE

Press the “**AUDIO**” button to display the audio screen.

▶ Without navigation function

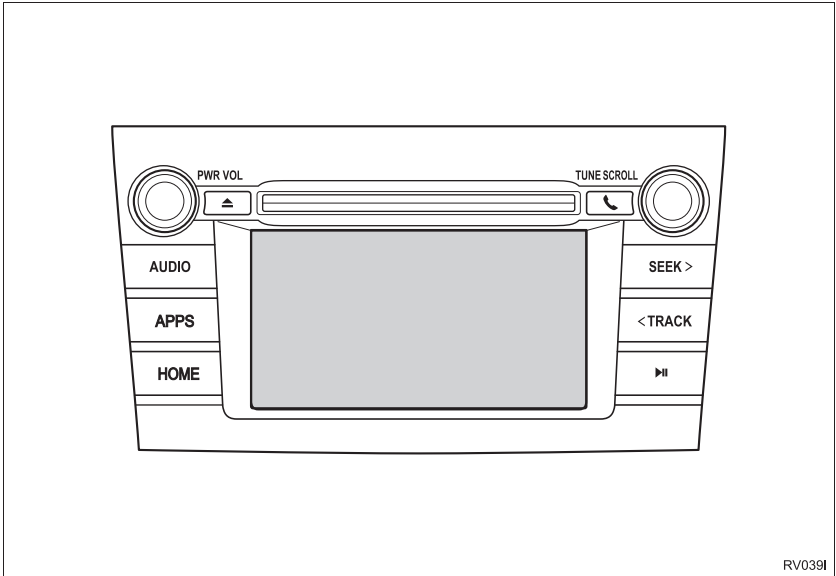

▶ With navigation function

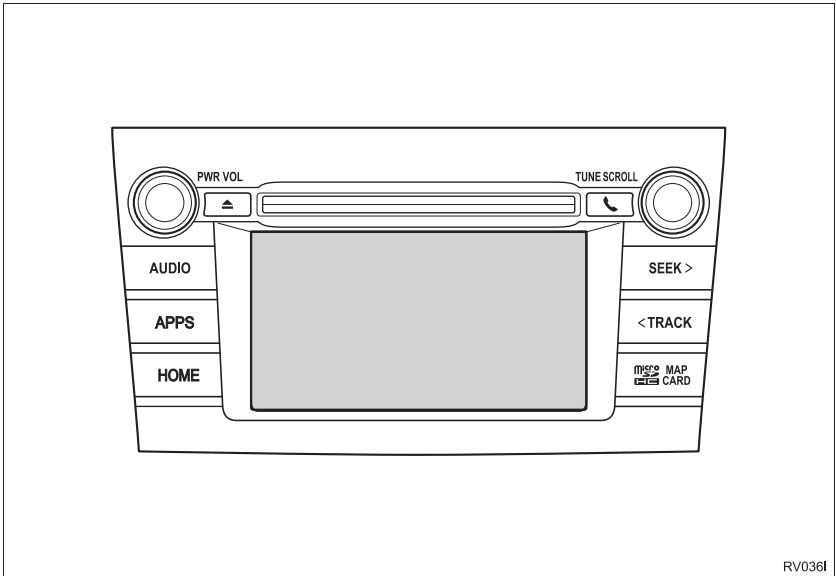

Function	Page
Using the radio	73, 83, 89
Playing an audio CD or MP3/WMA/AAC disc	90
Playing a USB memory	93
Playing an iPod®	97
Playing a Bluetooth® device	101
Using the AUX port	106
Using the steering wheel audio switches	108
Audio system settings	111

INFORMATION

- The display and button positions will differ depending on the type of the system.

2. SOME BASICS

This section describes some of the basic features of the audio system. Some information may not pertain to your system.

▶ Vehicles without a smart key system

Your audio system works when the engine switch is turned to the “ACC” or “ON” position.

▶ Vehicles with a smart key system

Your audio system works when the engine switch is turned to ACCESSORY or IGNITION ON mode.

⚠ CAUTION

● For vehicles sold in U.S.A.:
Part 15 of the FCC Rules
FCC WARNING: Changes or modifications not expressly approved by the party responsible for compliance could void the user's authority to operate the equipment.

● Laser products

▶ Without navigation function

- USE OF CONTROL OR ADJUSTMENT OR PERFORMANCE OF PROCEDURES OTHER THAN THOSE SPECIFIED HEREIN MAY RESULT IN HAZARDOUS RADIATION EXPOSURE.
- THE USE OF OPTICAL INSTRUMENTS WITH THIS PRODUCT WILL INCREASE EYE HAZARD.

▶ With navigation function

THIS PRODUCT IS A CLASS 1 LASER PRODUCT. USE OF CONTROLS OR ADJUSTMENTS OR PERFORMANCE OF PROCEDURES OTHER THAN THOSE SPECIFIED HEREIN MAY RESULT IN HAZARDOUS RADIATION EXPOSURE. DO NOT OPEN COVERS AND DO NOT REPAIR BY YOURSELF. REFER SERVING TO QUALIFIED PERSONNEL.

⚠ NOTICE

- To prevent the battery from being discharged, do not leave the audio system on longer than necessary when the engine is not running.

TURNING THE SYSTEM ON AND OFF

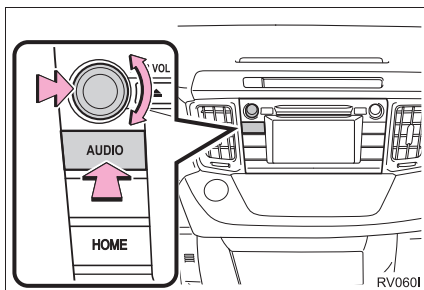

“PWR VOL” knob: Press to turn the audio system on and off. The system turns on in the last mode used. Turn this knob to adjust the volume.

“AUDIO” button: Press to display screen buttons for the audio system.

- A function that enables automatic return to the home screen from the audio screen can be selected. (→P.53)

SELECTING AN AUDIO SOURCE

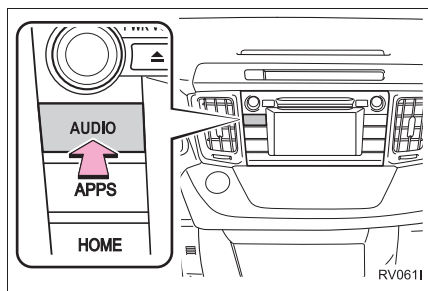

- 1 Press the **"AUDIO"** button.



- 2 Select **"Source"** on the audio screen or press **"AUDIO"** button again.
- 3 Select the desired source.





INFORMATION

- Dimmed screen buttons cannot be operated.
- When there are two pages, select  or  to change the page.

REORDERING THE AUDIO SOURCE

- 1 Display the **"Select Audio Source"** screen. (→P.69)
- 2 Select **"Reorder"**.



- 3 Select the desired audio source then  or  to reorder.



- 4 Select **"OK"**.

DISC SLOT

INSERTING A DISC

- 1 Insert a disc into the disc slot.

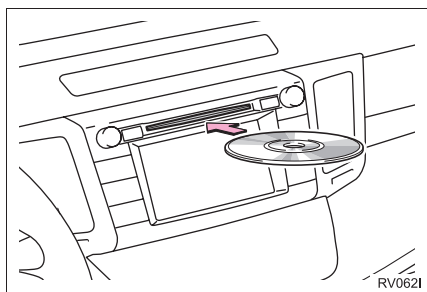

- After insertion, the disc is automatically loaded.

EJECTING A DISC

- 1 Press the ▲ button and remove the disc.

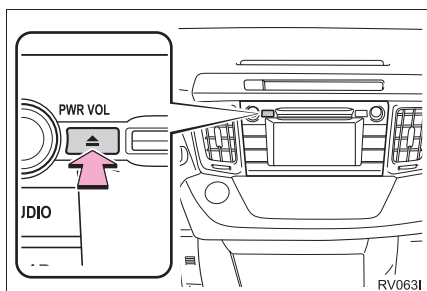

NOTICE

- Never try to disassemble or oil any part of the CD player. Do not insert anything other than a disc into the slot.

INFORMATION

- The player is intended for use with 4.7 in. (12 cm) discs only.
- When inserting a disc, gently insert the disc with the label facing up.

USB/AUX PORT

- 1 Open the cover and connect a device.

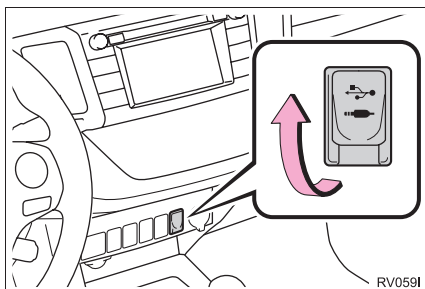

- Turn on the power of the device if it is not turned on.

INFORMATION

- If a USB hub is plugged-in, two devices can be connected at a time.
- Even if a USB hub is used to connect more than two USB devices, only the first two connected devices will be recognized.

SOUND SETTINGS

AUTOMATIC SOUND LEVELIZER (ASL)

The system adjusts to the optimum volume and tone quality according to vehicle speed to compensate for increased vehicle noise.

- 1 Display the “Audio Settings” screen. (→P.111)
- ▶ Type A
- 2 Select “**Automatic Sound Levelizer**”.
- 3 Select “**High**”, “**Mid**”, “**Low**”, or “**Off**”.
- ▶ Type B
- 2 Select “**Auto Sound Levelizer**”.

STONE AND BALANCE

STONE:

How good an audio program sounds is largely determined by the mix of the treble, mid and bass levels. In fact, different kinds of music and vocal programs usually sound better with different mixes of treble, mid and bass.

BALANCE:

A good balance of the left and right stereo channels and of the front and rear sound levels is also important.

Keep in mind that when listening to a stereo recording or broadcast, changing the right/left balance will increase the volume of 1 group of sounds while decreasing the volume of another.

1 Select **“Sound”** on the audio control screen.

2 Select the desired screen button.

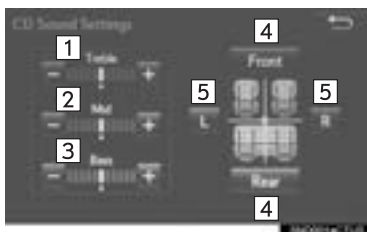

No.	Function
1	Select “+” or “-” to adjust high-pitched tones.
2	Select “+” or “-” to adjust mid-pitched tones.
3	Select “+” or “-” to adjust low-pitched tones.
4	Select to adjust the sound balance between the front and rear speakers.
5	Select to adjust the sound balance between the left and right speakers.

VOICE COMMAND SYSTEM

1 Press this switch to operate the voice command system.

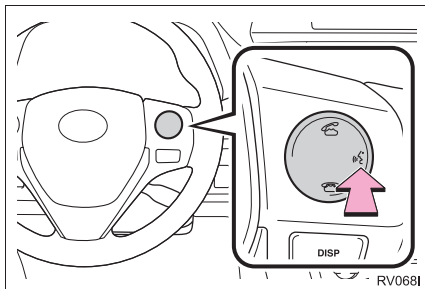

- The voice command system and its list of commands can be operated. (→P.124)

1. AM/FM RADIO

OVERVIEW

Select "AM" or "FM" on the "Select Audio Source" screen. (→P.69)

CONTROL SCREEN

▶ Without navigation function

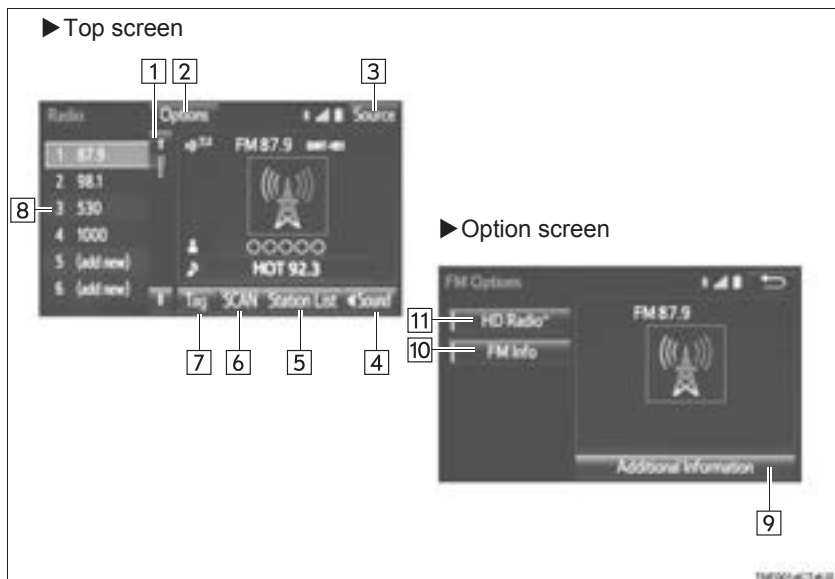

► With navigation function

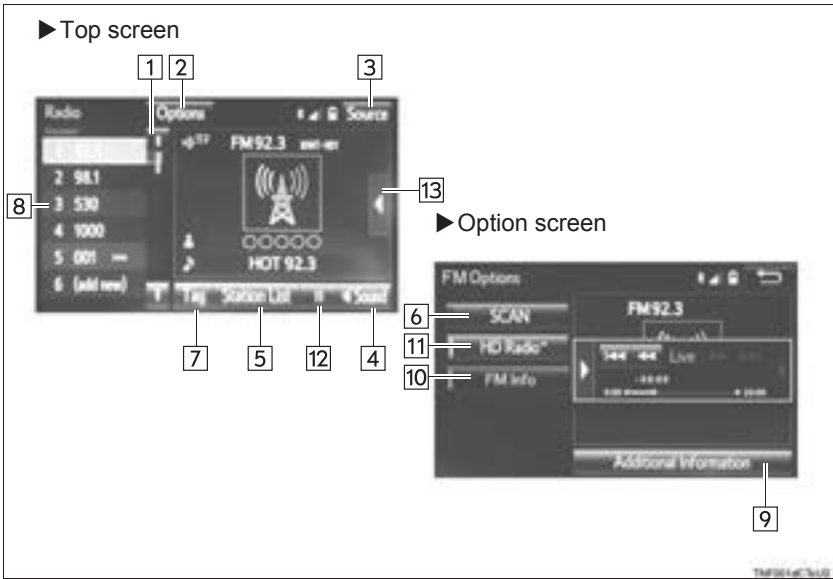

CONTROL PANEL

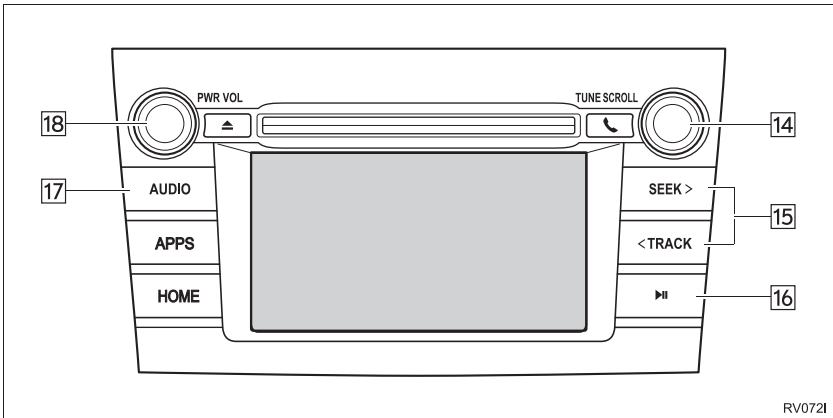

RV072I

No.	Function
1	Select to scroll the page of preset buttons.
2	Select to display the option screen.
3	Select to display the audio source selection screen.
4	Select to display the sound setting screen.
5	Select to display a list of receivable stations/channels.
6	Select to scan for receivable stations/channels.
7	Select to store information of the audio currently being broadcast on the radio.
8	Select to tune to preset stations/channels.
9	Select to display the additional text information.
10	Analog FM only: Select to display RBDS text messages.
11	Select to turn HD Radio mode on/off. When the “ HD Radio™ ” indicator is off, the station list shows only analog broadcasts.
12	Cache radio only: Select to turn mute on/off.
13	Select to display the cache radio operation buttons. (→P.77)
14	<ul style="list-style-type: none"> • Turn to step up/down frequencies. • Turn to move up/down the list. Also, the knob can be used to enter selections on the list screens by pressing it.
15	<ul style="list-style-type: none"> • Press to seek for a station/channel. • Press and hold for continuous seek.
16*	Press to turn mute on/off.
17	Press to select an audio mode.
18	<ul style="list-style-type: none"> • Turn to adjust volume. • Press to turn the audio system on/off. • Press and hold to restart the audio system.

*: Without navigation function

INFORMATION

- The radio automatically changes to stereo reception when a stereo broadcast is received.
- The radio automatically blends to an HD Radio signal in AM or FM where available.

PRESETTING A STATION

Radio mode has a mix preset function, which can store up to 36 stations (6 stations per page x 6 pages) from any of the AM, FM or SAT bands.

- 1 Tune in the desired station.
- 2 Select “(add new)”.



- To change the preset station to a different one, select and hold the preset station.
- 3 Select “**Yes**” on the confirmation screen.
 - 4 Select “**OK**” after setting the new preset station.

INFORMATION

- The number of preset radio stations displayed on the screen can be changed. (→P.112)

SELECTING A STATION FROM THE LIST

A station list can be displayed.

- 1 Select “**Station List**”.
- 2 FM radio only: Select the desired program genre.



- 3 Select the desired station and select “**OK**”.

REFRESHING THE STATION LIST

- 1 Select “**Refresh**” on the station list screen and the following screen will be displayed.



“**Cancel Refresh**”: Select to cancel the refresh.

“**Source**”: Select to change to another audio source while refreshing.

INFORMATION

- The audio system sound is muted during refresh operation.
- In some situations, it may take some time to update the station list.

CACHING A RADIO PROGRAM*

A radio program can be cached and played back in a time-shifted manner.

PLAYING BACK THE CACHE MANUALLY

The broadcast cached in the program cache can be played back manually.

- 1 Display the cache radio operation buttons. (→P.73)
- 2 Select the desired cache radio operation button.

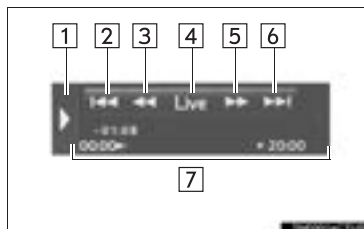

No.	Function
1	Hides the cache operation buttons
2	Skips backward 2 minutes
3	Fast rewinds continuously
4	Returns to the live radio broadcast
5	Fast forwards continuously
6	Skips forward 2 minutes
7	Red vertical bar: Shows what portion of the cached broadcast is currently playing Light blue bar: Shows time in which cache writing is in progress

*: With navigation function

AUTOMATIC PLAYBACK OF THE CACHE

If the radio broadcast is interrupted by another audio output, such as an incoming phone call, the system will automatically cache the interrupted portion and perform time-shift playback when the interruption ends. To manually operate the cache operation: (→P.77)

INFORMATION

- The system can store up to 20 minutes. Cached data will be erased when the radio mode or station is changed or when the audio system is turned off.
- If noise or silence occurs during the caching process, cache writing will continue, with the noise or silence recorded as is. In this case, the cached broadcast will contain the noise or silence when played back.

RADIO BROADCAST DATA SYSTEM

This audio system is equipped with Radio Broadcast Data Systems (RBDS). RBDS mode allows text messages to be received from radio stations that utilize RBDS transmitters.

When RBDS is on, the radio can

- only select stations of a particular program type,
- display messages from radio stations,
- search for a stronger signal station.

RBDS features are available only when listening to an FM station that broadcasts RBDS information and the “**FM Info**” indicator is on.

SELECTING A DESIRED GENRE

- 1 Select “**Station List**”.
- 2 FM radio only: Select a desired genre of station and select a desired station.
 - The genre list is in the following order:
 - Classical
 - Country
 - EasyLis (Easy Listening)
 - Inform (Information)
 - Jazz
 - News
 - Oldies
 - Other
 - Pop Music
 - Religion
 - Rock
 - R&B (Rhythm and Blues)
 - Sports
 - Talk
 - Traffic (Not available when “HD Radio™” indicator is off.)
 - Alert (Emergency Alert)

TRAFFIC ANNOUNCEMENT (FM RADIO)

A station that regularly broadcasts traffic information is automatically located.

- 1 Select “**Station List**”.
- 2 Select the desired traffic program station.

INFORMATION

- If a traffic program station is found, the name of the traffic program station will be displayed for a while.

USING HD Radio™ TECHNOLOGY

HD Radio™ Technology is the digital evolution of analog AM/FM radio. Your radio product has a special receiver which allows it to receive digital broadcasts (where available) in addition to the analog broadcasts it already receives. Digital broadcasts have better sound quality than analog broadcasts as digital broadcasts provide free, crystal clear audio with no static or distortion. For more information, and a guide to available radio stations and programming, refer to www.hdradio.com.

HD Radio®

HD Radio Technology manufactured under license from iBiquity Digital Corporation. U.S. and Foreign Patents. HD Radio™ and the HD, HD Radio, and “Arc” logos are proprietary trademarks of iBiquity Digital Corp.

AVAILABLE HD Radio™ TECHNOLOGY

MULTICAST

On the FM radio frequency most digital stations have “multiple” or supplemental programs on one FM station.

1 Select the “HD” logo.



2 Select the desired channel.

- Turning the “TUNE/SCROLL” knob can also select the desired multicast channel.

PRESERVING A MUSIC INFORMATION

Tag information in the music broadcasting is preserved in the system and transmits to an iPod.

1 Select “Tag” to bookmark the music information.



2 Connect an iPod. (→P.70)

- Turn on the power of the iPod if it is not turned on.
- Once an iPod is connected, the music tag moves from the radio into the iPod.
- When the iPod is connected to iTunes, the “tagged” information of the songs which were tagged while listening to the radio can be viewed. Then a user may decide to purchase the song or CD/Album which had been listened to on their radio.

INFORMATION

- The tag information can not be preserved while scanning or caching the radio station.
- If tagging the music information fails, “Saving the HD Radio tag was unsuccessful.” will be displayed on the screen. If this occurs, tag the information again.
- HD Radio™ stations can be preset.
- An orange “HD)” logo indicator will be displayed on the screen when in digital. The “HD)” logo will first appear in a gray color indicating the station is indeed (an analog and) a digital station. Once the digital signal is acquired, the logo will change to a bright orange color.
- The song title and artist name will appear on the screen when available by the radio station. The radio station can send album pictures when available.
- As a user works through the analog radio stations, (where applicable) the radio receiver will automatically tune from an analog signal to a digital signal within 5 seconds.

TROUBLESHOOTING GUIDE

Experience	Cause	Action
Mismatch of time alignment- a user may hear a short period of programming replayed or an echo, stutter or skip.	The radio stations analog and digital volume is not properly aligned or the station is in ballgame mode.	None, radio broadcast issue. A user can contact the radio station.
Sound fades, blending in and out.	Radio is shifting between analog and digital audio.	Reception issue, may clear-up as the vehicle continues to be driven. Turning the indicator of the "HD Radio™" button off can force radio in an analog audio.
Audio mute condition when an HD2/HD3 multicast channel had been playing.	The radio does not have access to digital signals at the moment.	This is normal behavior, wait until the digital signal returns. If out of the coverage area, seek a new station.
Audio mute delay when selecting an HD2/HD3 multicast channel preset.	The digital multicast content is not available until HD Radio™ broadcast can be decoded and make the audio available. This takes up to 7 seconds.	This is normal behavior, wait for the audio to become available.
Text information does not match the present song audio.	Data service issue by the radio broadcaster.	Broadcaster should be notified. Complete the form; www.ibiquity.com/automotive/report_radio_station_experiences .
No text information shown for the present selected frequency.	Data service issue by the radio broadcaster.	Broadcaster should be notified. Complete the form; www.ibiquity.com/automotive/report_radio_station_experiences .

2. XM Satellite Radio*

OVERVIEW

Select "XM" on the "Select Audio Source" screen. (→P.69)

CONTROL SCREEN

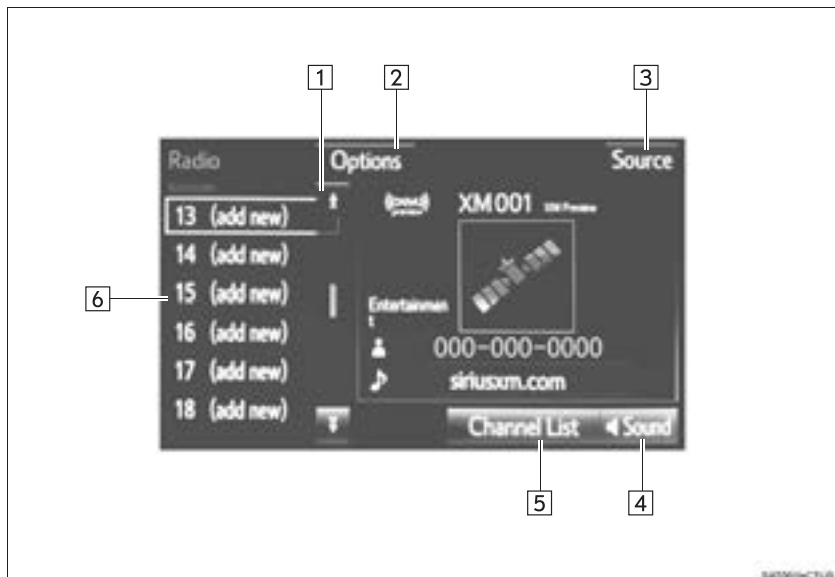

CONTROL PANEL

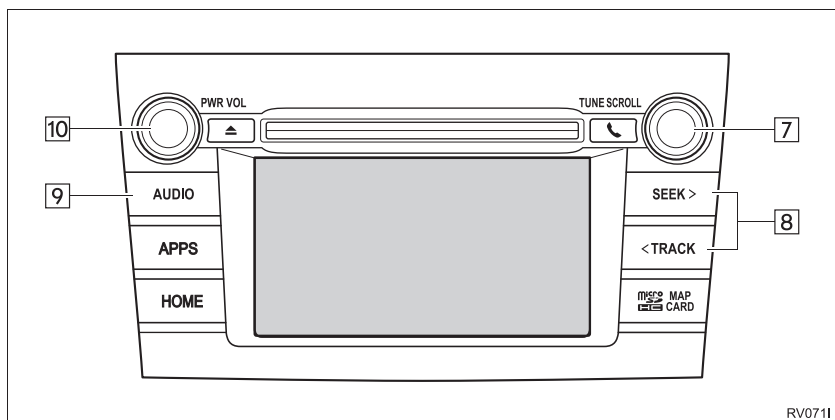

RV0711

*: With navigation function

No.	Function
1	Select to scroll the page of preset buttons.
2	Select to display the option screen. <ul style="list-style-type: none"> • Select to scan for receivable channels. • Select "Additional Information" to display the information.
3	Select to display the audio source selection screen.
4	Select to display the sound setting screen.
5	Select to display a list of receivable channels.
6	Select to tune to preset channels.
7	<ul style="list-style-type: none"> • Turn to step up/down channels. • Turn to move up/down the list. Also, the knob can be used to enter selections on the list screens by pressing it.
8	<ul style="list-style-type: none"> • Press to seek for a channel. • Press and hold for continuous seek.
9	Press to select an audio mode.
10	<ul style="list-style-type: none"> • Turn to adjust volume. • Press to turn the audio system on/off. • Press and hold to restart the audio system.

HOW TO SUBSCRIBE TO AN XM Satellite Radio

To listen to a satellite radio broadcast in the vehicle, a subscription to the XM Satellite Radio service is necessary.

An XM Satellite Radio is a tuner designed exclusively to receive broadcasts provided under a separate subscription. Availability is limited to the 48 contiguous U.S. states and some Canadian provinces.

HOW TO SUBSCRIBE

It is necessary to enter into a separate service agreement with XM Satellite Radio in order to receive satellite broadcast programming in the vehicle. Additional activation and service subscription fees apply that are not included in the purchase price of the vehicle and digital satellite tuner.

- For complete information on subscription rates and terms, or to subscribe to XM Satellite Radio:

▶ U.S.A.

Refer to www.siriusxm.com or call 1-800-967-2346.

▶ Canada

Refer to www.xmradio.ca or call 1-877-209-0079.



NOTICE

- XM Radio Services — Legal Disclaimers and Warnings
 - Fees and Taxes — Subscription fee, taxes, one time activation fee, and other fees may apply. Subscription fee is consumer only. All fees and programming subject to change. Subscriptions subject to Customer Agreement available at www.siriusxm.com. (U.S.A.) or www.xmradio.ca (Canada) XM service only available in the 48 contiguous United States and Canada.
 - Explicit Language Notice — Channels with frequent explicit language are indicated with an “XL” preceding the channel name. Channel blocking is available for XM Satellite Radio receivers by notifying XM at; U.S.A. Customers: Visit www.siriusxm.com or calling 1-800-967-2346 Canadian Customers: Visit www.xmradio.ca or calling 1-877-209-0079
- It is prohibited to copy, decompile, disassemble, reverse engineer, hack, manipulate, or otherwise make available any technology or software incorporated in receivers compatible with the XM Satellite Radio System or that support the XM website, the Online Service or any of its content. Furthermore, the AMBE[®] voice compression software included in this product is protected by intellectual property rights including patent rights, copyrights, and trade secrets of Digital Voice Systems, Inc.
- Note: this applies to XM receivers only and not XM Ready devices.

INFORMATION

- **XM Radio Services—Descriptions**
 - **Radio and Entertainment**
XM offers more than 170 satellite radio channels of commercial-free music and premier sports, news, talk, and entertainment. XM is broadcast via satellites to millions of listeners across the continental United States. XM subscribers listen to XM on satellite radio receivers for the car, home, and portable use. More information about XM is available online at www.siriusxm.com (U.S.A.) or www.xmradio.ca (Canada).
- **XM Radio Services—Subscription Instructions**
 - For XM Services requiring a subscription (such as XM Radio, and some Infotainment & data services), the following paragraph shall be included. Required XM Radio and some Infotainment & data services monthly subscriptions sold separately after trial period. Subscription fee is consumer only. All fees and programming subject to change. Subscriptions are subject to the Customer Agreement available at www.siriusxm.com. XM service only available in the 48 contiguous United States. © 2011 Sirius XM Radio Inc. Sirius, XM and all related marks and logos are trademarks of Sirius XM Radio Inc. All other marks, channel names and logos are the property of their respective owners.
For more information, program schedules, and to subscribe or extend subscription after complimentary trial period; more information is available at:
USA Customers:
Visit www.siriusxm.com or call
1-800-967-2346

INFORMATION

- XM Satellite Radio is solely responsible for the quality, availability and content of the satellite radio services provided, which are subject to the terms and conditions of the XM Satellite Radio customer service agreement.
- Customers should have their radio ID ready; the radio ID can be found by tuning to “Ch 000” on the radio. For details, see “DISPLAYING THE RADIO ID” below.
- All fees and programming are the responsibility of XM Satellite Radio and are subject to change.

**SATELLITE TUNER
TECHNOLOGY NOTICE**

Toyota’s satellite radio tuners are awarded Type Approval Certificates from XM Satellite Radio Inc. as proof of compatibility with the services offered by XM Satellite Radio.

INFORMATION

- **Satellite tuner**
The tuner supports only Audio Services (Music and Talk) and the accompanying Text Information of XM[®] Satellite Radio.

DISPLAYING THE RADIO ID

Each XM tuner is identified with a unique radio ID. The radio ID is required when activating an XM service or when reporting a problem.

- If “Ch 000” is selected using the “**TUNE/SCROLL**” knob, the ID code, which is 8 alphanumeric characters, will be displayed. If another channel is selected, the ID code will no longer be displayed. The channel (000) alternates between displaying the radio ID and the specific radio code.

PRESETTING A CHANNEL

- 1 Tune in the desired channel.
- 2 Select “**(add new)**”.



- To change the preset channel to a different one, select and hold the preset station/channel.
- 3 Select “**Yes**” on the confirmation screen.
 - 4 Select “**OK**” after setting the new preset channel.

SELECTING A CHANNEL FROM THE LIST

- 1 Select “**Channel List**”.
- 2 Select the desired program genre.
- 3 Select the desired channel and select “**OK**”.

3

AUDIO SYSTEM

IF THE SATELLITE RADIO TUNER MALFUNCTIONS

When problems occur with the XM tuner, a message will appear on the screen. Referring to the table below to identify the problem, take the suggested corrective action.

Message	Explanation
"Check Antenna"	The XM antenna is not connected. Check whether the XM antenna cable is attached securely.
	A short circuit occurs in the antenna or the surrounding antenna cable. See a Toyota certified dealer for assistance.
"Ch Unauthorized"	You have not subscribed to XM Satellite Radio. The radio is being updated with the latest encryption code. Contact XM Satellite Radio for subscription information. When a contract is canceled, you can choose "Ch 000" and all free-to-air channels.
	The premium channel you selected is not authorized. Wait for about 2 seconds until the radio returns to the previous channel or "Ch 001". If it does not change automatically, select another channel. To listen to the premium channel, contact XM Satellite Radio.
"No Signal"	The XM signal is too weak at the current location. Wait until your vehicle reaches a location with a stronger signal.
"Loading"	The unit is acquiring audio or program information. Wait until the unit has received the information.
"Channel Off Air"	The channel you selected is not broadcasting any programming. Select another channel.
-----	There is no song/program title or artist name/feature associated with the channel at that time. No action is required.
"Chan Unavailable"	The channel you selected is no longer available. Wait for about 2 seconds until the radio returns to the previous channel or "Ch 001". If it does not change automatically, select another channel.

INFORMATION

- Contact the XM Listener Care Center at 1-800-967-2346 (U.S.A.) or 1-877-209-0079 (Canada).

3. INTERNET RADIO*

LISTENING TO INTERNET RADIO

One of Entune App Suite features is the ability to listen to internet radio. In order to use this service, a compatible phone and the system needs to be set up. For details: →P.265

- 1 Select the internet radio application.



- The internet radio application screen is displayed.
- Perform operations according to the displayed application screen.
- For the instrument panel operation method: →P.69
- If a compatible phone is already registered, it will be connected automatically.

INFORMATION

- Other applications can be activated while listening to internet radio.
- If an iPhone is connected via Bluetooth® and USB at the same time, system operation may become unstable. For known phone compatibility information, refer to <http://www.toyota.com/entune/>.
- Some parts of applications can be adjusted using the switches on the steering wheel.
- For additional information, refer to <http://www.toyota.com/entune/> or call 1-800-331-4331.

*: With navigation function

1. CD

OVERVIEW

The CD operation screen can be reached by the following methods:

- ▶ Insert a disc. (→P.70)
- ▶ Select “CD” on the “Select Audio Source” screen. (→P.69)

CONTROL SCREEN



CONTROL PANEL

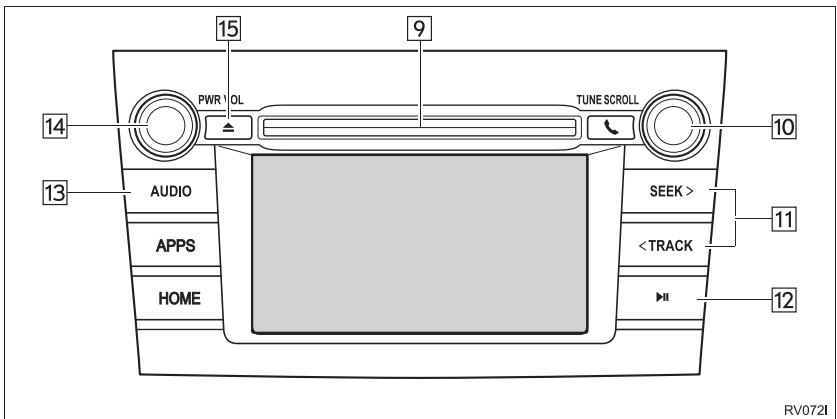

No.	Function
1	<ul style="list-style-type: none"> • Displays cover art • Select to display a track/file list.
2	Select to display the audio source selection screen.
3	Select to display the sound setting screen.
4	Select to play/pause.
5	Shows progress
6	Select to set repeat playback.
7	Select to set random playback.
8	<ul style="list-style-type: none"> • Audio CD: Select to display a track list. • MP3/WMA/AAC disc: Select to display a folder list. To return to the top screen, select " Now Playing " on the list screen.
9	Disc slot
10	<ul style="list-style-type: none"> • Turn to select a track/file. • Turn to move up/down the list. Also, the knob can be used to enter selections on the list screens by pressing it.
11	<ul style="list-style-type: none"> • Press to select a track/file. • Press and hold to fast forward/rewind.
12*	Press to play/pause.
13	Press to select an audio mode.
14	<ul style="list-style-type: none"> • Turn to adjust volume. • Press to turn the audio system on/off. • Press and hold to restart the audio system.
15	Press to eject a disc.

*: Without navigation function

INFORMATION

- If a disc contains CD-DA files and MP3/WMA/AAC files, only the CD-DA files can be played back.
- If a CD-TEXT disc is inserted, the title of the disc and track will be displayed. Up to 32 characters can be displayed.
- If the disc contains no CD-TEXT, only the track number would be displayed on the screen.

PLAYING AN AUDIO CD

REPEATING

The track currently being listened to can be repeated.

- 1 Select the repeat button to change on/off.

RANDOM ORDER

Tracks can be automatically and randomly selected.

- 1 Select the random button to change on/off.

PLAYING AN MP3/WMA/AAC DISC

REPEATING

The file currently being listened to can be repeated.

- 1 Select the repeat button to change on/off.

RANDOM ORDER

Files can be automatically and randomly selected.

- 1 Select the random button to change on/off.

2. USB MEMORY

OVERVIEW

The USB memory operation screen can be reached by the following methods:

- ▶ Connect a USB memory. (→P.70)
- ▶ Select “USB (DEVICE NAME)” on the “Select Audio Source” screen. (→P.69)

CONTROL SCREEN

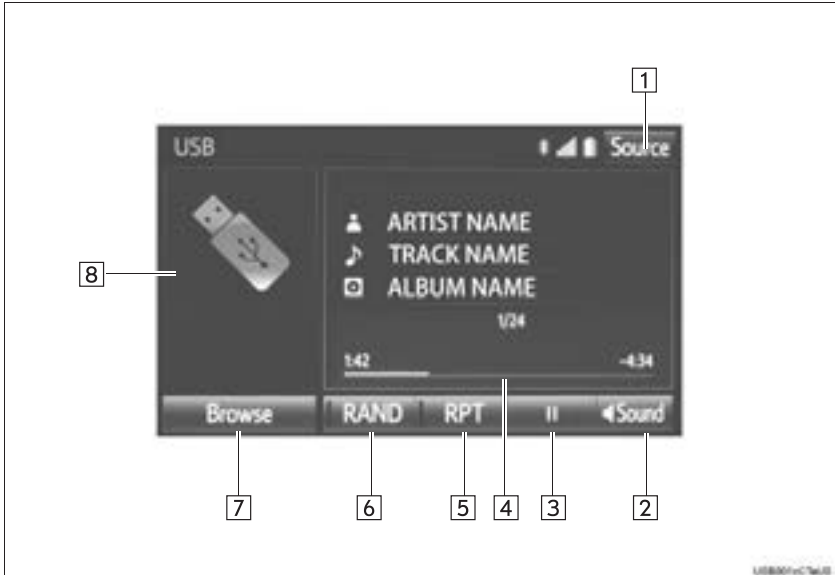

CONTROL PANEL

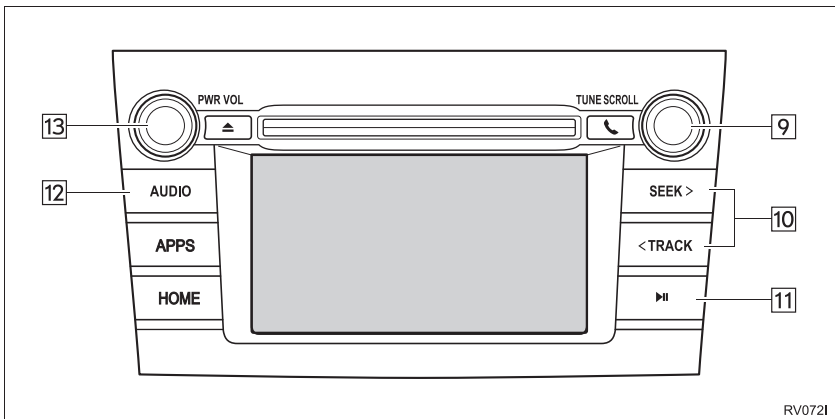

No.	Function
1	Select to display the audio source selection screen.
2	Select to display the sound setting screen.
3	Select to play/pause.
4	Shows progress
5	Select to set repeat playback.
6	Select to set random playback.
7	Select to display the play mode selection screen. To return to the top screen, select " Now Playing " on the list screen.
8	<ul style="list-style-type: none"> • Displays cover art • Select to display file/track list.
9	<ul style="list-style-type: none"> • Turn to select a file/track. • Turn to move up/down the list. Also, the knob can be used to enter selections on the list screens by pressing it.
10	<ul style="list-style-type: none"> • Press to select a file/track. • Press and hold to fast forward/rewind.
11*	Press to play/pause.
12	Press to select an audio mode.
13	<ul style="list-style-type: none"> • Turn to adjust volume. • Press to turn the audio system on/off. • Press and hold to restart the audio system.

*: Without navigation function

**CAUTION**

- Do not operate the player's controls or connect the USB memory while driving.

**NOTICE**

- Do not leave your portable player in the car. In particular, high temperatures inside the vehicle may damage the portable player.
- Do not push down on or apply unnecessary pressure to the portable player while it is connected as this may damage the portable player or its terminal.
- Do not insert foreign objects into the port as this may damage the portable player or its terminal.

INFORMATION

- If tag information exists, the file names will be changed to track names.

PLAYING A USB AUDIO

REPEATING

The file/track currently being listened to can be repeated.

- 1 Select the repeat button to change on/off.

RANDOM ORDER

Files/tracks can be automatically and randomly selected.

- 1 Select the random button to change on/off.

3. iPod

OVERVIEW

The iPod operation screen can be reached by the following methods:

- ▶ Connect an iPod. (→P.70)
- ▶ Select “**iPod (DEVICE NAME)**” on the “Select Audio Source” screen. (→P.69)

When the iPod connected to the system includes iPod video, the system can only output the sound by selecting the browse screen. (→P.100)

CONTROL SCREEN

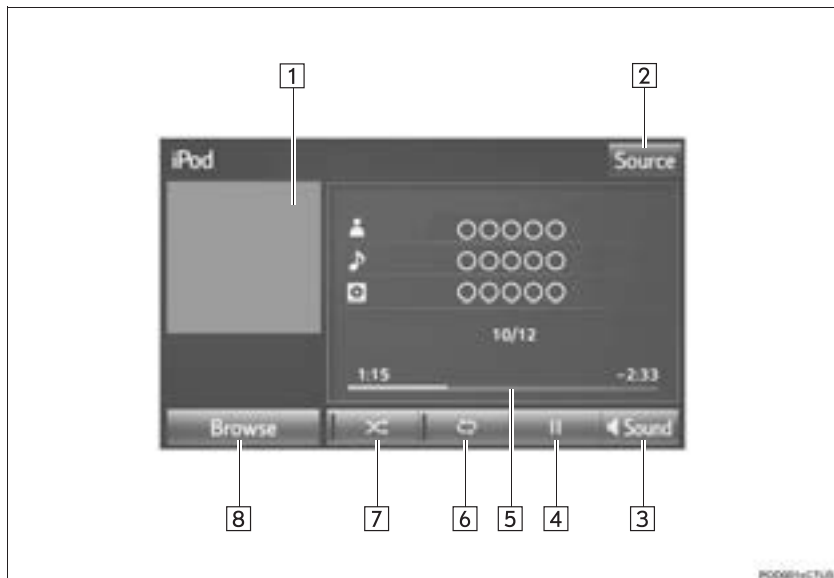

■ CONTROL PANEL

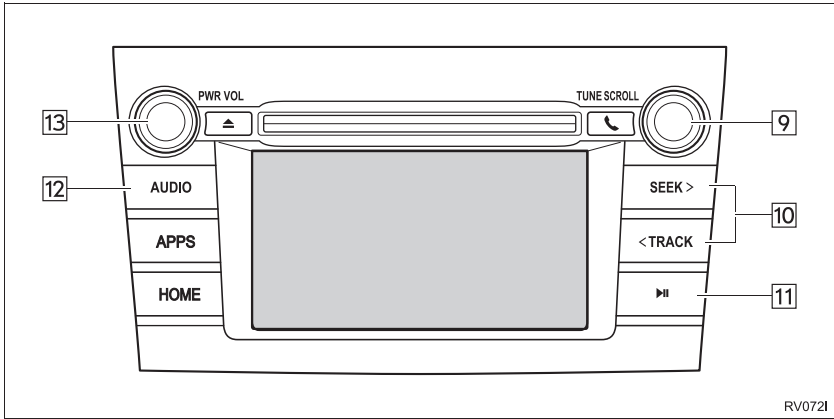

RV072I

No.	Function
1	<ul style="list-style-type: none"> • Displays cover art • Select to display a track list.
2	Select to display the audio source selection screen.
3	Select to display the sound setting screen.
4	Select to play/pause.
5	Shows progress
6	Select to set repeat playback.
7	Select to set random playback.
8	Select to display the play mode selection screen. To return to the top screen, select " Now Playing " on the list screen.
9	<ul style="list-style-type: none"> • Turn to select a track. • Turn to move up/down the list. Also, the knob can be used to enter selections on the list screens by pressing it.
10	<ul style="list-style-type: none"> • Press to select a track. • Press and hold to fast forward/rewind.
11*	Press to play/pause.
12	Press to select an audio mode.

No.	Function
13	<ul style="list-style-type: none"> • Turn to adjust volume. • Press to turn the audio system on/off. • Press and hold to restart the audio system.

*: Without navigation function



CAUTION

- Do not operate the player's controls or connect the iPod while driving.



NOTICE

- Do not leave your portable player in the car. In particular, high temperatures inside the vehicle may damage the portable player.
- Do not push down on or apply unnecessary pressure to the portable player while it is connected as this may damage the portable player or its terminal.
- Do not insert foreign objects into the port as this may damage the portable player or its terminal.

INFORMATION

- When an iPod is connected using a genuine iPod cable, the iPod starts charging its battery.
- Depending on the iPod, the video sound may not be able to be heard.
- Depending on the iPod and the songs in the iPod, iPod cover art may be displayed. This function can be changed to on/off. (→P.111) It may take time to display iPod cover art, and the iPod may not be operated while the cover art display is in process.
- When an iPod is connected and the audio source is changed to iPod mode, the iPod will resume playing from the same point it was last used.
- Depending on the iPod that is connected to the system, certain functions may not be available.
- Files/tracks selected by operating a connected iPod may not be recognized or displayed properly.
- If an iPhone is connected via Bluetooth® and USB at the same time, system operation may become unstable.

For known phone compatibility information, refer to <http://www.toyota.com/entune/>.

iPod AUDIO

REPEATING

The track currently being listened to can be repeated.

- 1 Select the repeat button to change on/off.

RANDOM ORDER

Tracks can be automatically and randomly selected.

- 1 Select the shuffle button to change on/off.

iPod VIDEO

To change to iPod video mode, select **“Browse”** on the iPod audio screen, then select the **“Videos”** tab and select the desired video file.

The system can only output the iPod video sound.

4. Bluetooth® AUDIO

The Bluetooth® audio system enables users to enjoy listening to music that is played on a portable player on the vehicle speakers via wireless communication.

This audio system supports Bluetooth®, a wireless data system capable of playing portable audio music without cables. If your device does not support Bluetooth®, the Bluetooth® audio system will not function.

OVERVIEW

Select “ **Audio**” on the “Select Audio Source” screen. (→P.69)

Depending on the type of portable player connected, some functions may not be available and/or the screen may look differently than shown in this manual.

CONTROL SCREEN

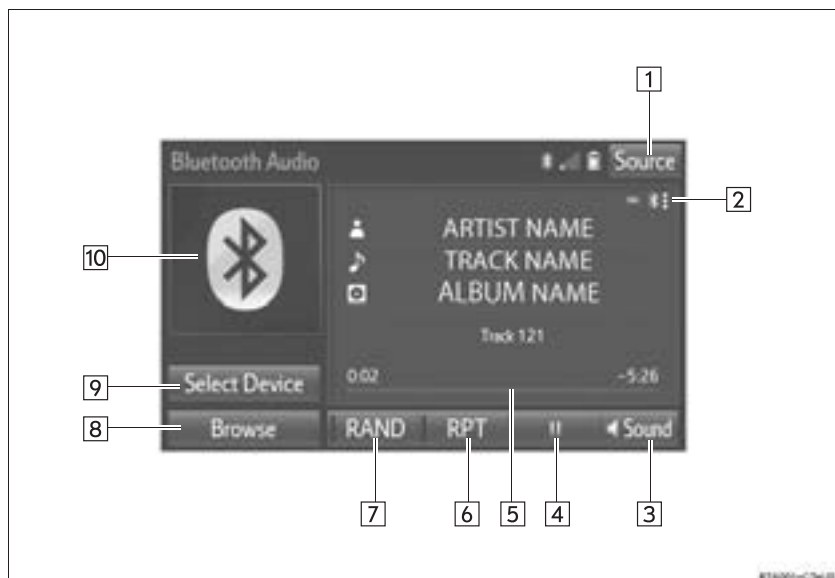

■ CONTROL PANEL

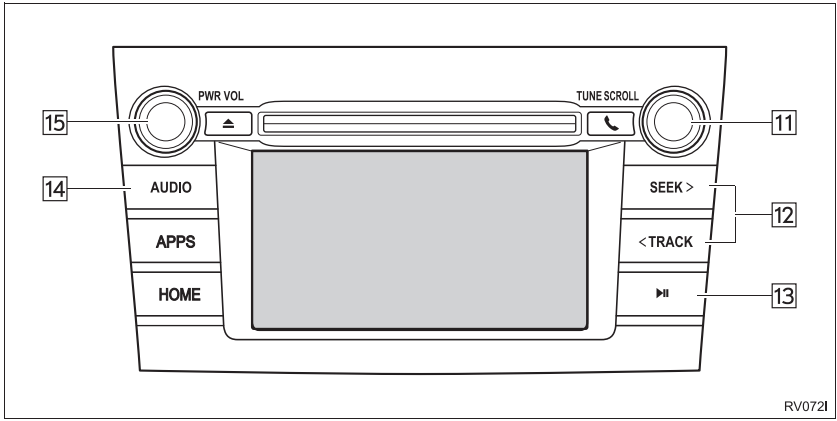

No.	Function
1	Select to display the audio source selection screen.
2	Displays Bluetooth® device condition.
3	Select to display the sound settings screen.
4	Select to play/pause.
5	Shows progress
6	Select to set repeat playback.
7	Select to set random playback.
8	Select to display the playlist screen. To return to the top screen, select “Now Playing” on the list screen.
9	Select to display the portable device connection screen.
10	<ul style="list-style-type: none"> • Displays cover art • Select to display a track list.
11	<ul style="list-style-type: none"> • Turn to select a track. • Turn to move up/down the list. Also, the knob can be used to enter selections on the list screens by pressing it.
12	<ul style="list-style-type: none"> • Press to select a track. • Press and hold to fast forward/rewind.
13*	Press to play/pause.
14	Press to select an audio mode.
15	<ul style="list-style-type: none"> • Turn to adjust volume. • Press to turn the audio system on/off. • Press and hold to restart the audio system.

*: Without navigation function



 **CAUTION**

- Do not operate the player's controls or connect to the Bluetooth® audio system while driving.
- Your audio unit is fitted with Bluetooth® antennas. People with implantable cardiac pacemakers, cardiac resynchronization therapy-pacemakers or implantable cardioverter defibrillators should maintain a reasonable distance between themselves and the Bluetooth® antennas. The radio waves may affect the operation of such devices.
- Before using Bluetooth® devices, users of any electrical medical device other than implantable cardiac pacemakers, cardiac resynchronization therapy-pacemakers or implantable cardioverter defibrillators should consult the manufacturer of the device for information about its operation under the influence of radio waves. Radio waves could have unexpected effects on the operation of such medical devices.

 **NOTICE**

- Do not leave your portable player in the vehicle. In particular, high temperatures inside the vehicle may damage the portable player.

INFORMATION

- Depending on the Bluetooth® device that is connected to the system, the music may start playing when selecting  while it is paused. Conversely, the music may pause when selecting  while it is playing.
- In the following conditions, the system may not function:
 - The Bluetooth® device is turned off.
 - The Bluetooth® device is not connected.
 - The Bluetooth® device has a low battery.
- It may take time to connect the phone when Bluetooth® audio is being played.
- For operating the portable player, see the instruction manual that comes with it.
- If the Bluetooth® device is disconnected due to poor reception from the Bluetooth® network when the engine switch is in the following, the system will automatically reconnect to the portable player.
 - ▶ Vehicles without a smart key system
The engine switch is turned to the "ACC" or "ON" position.
 - ▶ Vehicles with a smart key system
The engine switch is turned to ACCESSORY or IGNITION ON mode.
- If the Bluetooth® device is disconnected on purpose, such as it was turned off, this does not happen. Reconnect the portable player manually.
- Bluetooth® device information is registered when the Bluetooth® device is connected to the Bluetooth® audio system. When selling or disposing of the vehicle, remove the Bluetooth® audio information from the system. (→P.58)

CONNECTING A Bluetooth® DEVICE

To use the Bluetooth® audio system, it is necessary to register a Bluetooth® device with the system.

► Registering an additional device

1 Select **“Select Device”** on the Bluetooth® audio control screen.

2 For more information: →P.46

► Selecting a registered device

1 Select **“Select Device”** on the Bluetooth® audio control screen.

2 For more information: →P.48

LISTENING TO Bluetooth® AUDIO

REPEATING

The track currently being listened to can be repeated.

1 Select the repeat button to change on/off.

RANDOM ORDER

Tracks can be automatically and randomly selected.

1 Select the random button to change on/off.

5. AUX

OVERVIEW

Select **"AUX"** on the "Select Audio Source" screen. (→P.69)

CONTROL SCREEN

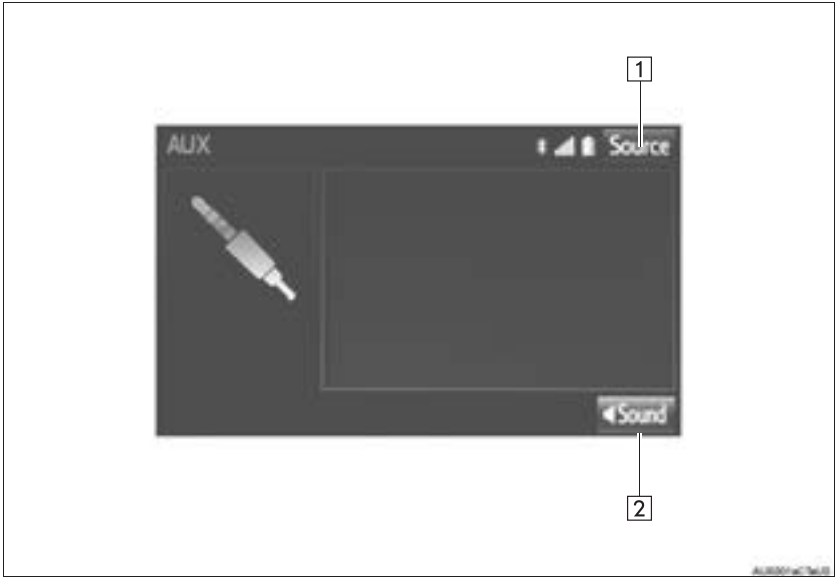

CONTROL PANEL

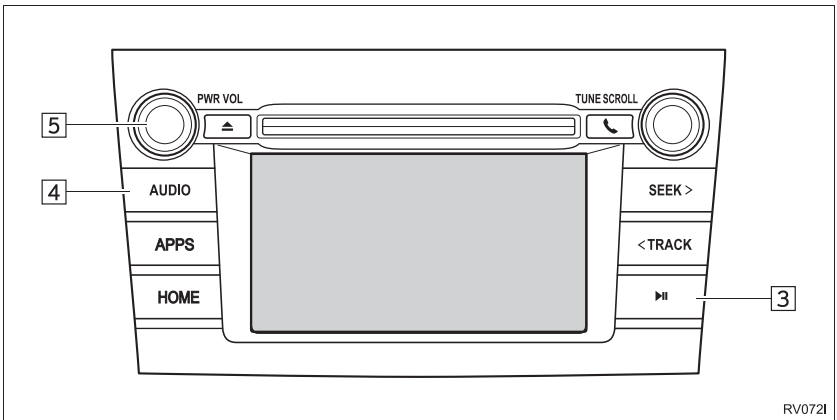

No.	Function
1	Select to display the audio source selection screen.
2	Select to display the sound setting screen.
3*	Press to turn mute on/off.
4	Press to select an audio mode.
5	<ul style="list-style-type: none"> • Turn to adjust volume. • Press to turn the audio system on/off. • Press and hold to restart the audio system.

*: Without navigation function



CAUTION

- Do not connect portable audio device or operate the controls while driving.



NOTICE

- Do not leave portable audio device in the vehicle. The temperature inside the vehicle may become high, resulting in damage to the player.
- Do not push down on or apply unnecessary pressure to the portable audio device while it is connected as this may damage the portable audio device or its terminal.
- Do not insert foreign objects into the port as this may damage the portable audio device or its terminal.

1. STEERING SWITCHES

Some parts of the audio system can be adjusted using the switches on the steering wheel.

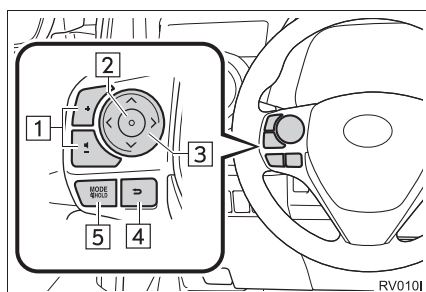

No.	Switch
1	Volume control switch
2	Enter switch
3	“^ v < >” switch
4	Back switch
5	“MODE/HOLD” switch

► Volume control switch

Mode	Operation	Function
All	Press	Volume up/down
	Press and hold	Volume up/down continuously

► Enter switch

Mode	Operation	Function
Control screen	Press	Show list screen
List screen	Press	Select cursor entry
Navigation screen/ home screen	Press	Return to the top screen of current mode.

▶ “v ^” switch

Mode	Operation	Function
AM/FM Radio	Press	Preset station/channel up/down Station/channel list up/down
	Press and hold	Fast preset station/channel up/down Fast station/channel list up/down
XM	Press	Preset channel up/down Channel list up/down
	Press and hold	Fast preset channel up/down Fast channel list up/down
Audio CD, MP3/ WMA/AAC disc, USB, iPod, BT audio	Press	Track/file up/down Track/file list up/down
	Press and hold	Fast track/file up/down Fast track/file list up/down

▶ “> <” switch

Mode	Operation	Function
AM/FM Radio	Press	Seek up/down
	Press and hold	Seek up/down continuously while the switch is being pressed
XM	Press	Type seek up/down
	Press and hold	Fast channel up/down
Audio CD, MP3/ WMA/AAC disc, USB, iPod, BT audio	Press	Tab selection*
	Press and hold	Fast forward/rewind

*: USB, iPod only

▶ Back switch

Mode	Operation	Function
All	Press	Return to the previous screen

▶ “MODE/HOLD” switch

Mode	Operation	Function
AM, FM, XM, AUX	Press	Change audio modes
	Press and hold	Mute (Press and hold again to resume the sound.)
Audio CD/ MP3/WMA/ AAC disc, USB, iPod, BT audio, APPS	Press	Change audio modes
	Press and hold	Pause (Press and hold again to resume the playmode.)

INFORMATION

- In the APPS mode, some operation may be done on the screen depend on the selected APPS.

1. AUDIO SETTINGS

Detailed audio settings can be programmed.

- 1 Press the “APPS” button.

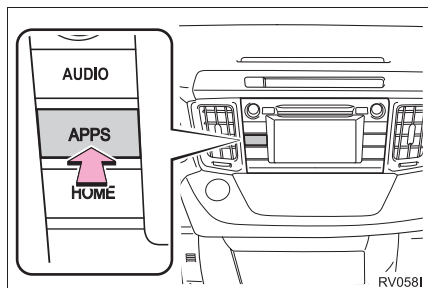

- 2 Select “Setup”.
- 3 Select “Audio”.
- 4 Select the items to be set.

AUDIO SETTINGS SCREEN



No.	Function	Page
1	Select to change the number of preset radio stations/channels displayed on the screen.	112
2	Select to set cover art settings on/off.	—
3	Select to set automatic sound levelizer.	71
4*	Select to enable cache radio.	—
5	Select to reset all setup items.	—

*: With navigation function

SETTING THE NUMBER OF RADIO PRESETS

- 1 Display the “Audio Settings” screen. (→P.111)
- 2 Select “**Number of Radio Presets**”.
- 3 Select the button with the desired number to be displayed.

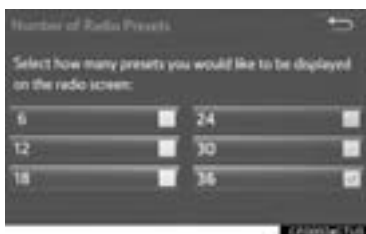

1. OPERATING INFORMATION

**NOTICE**

- To avoid damage to the audio system:
 - Be careful not to spill beverages over the audio system.
 - Do not put anything other than an appropriate disc into the disc slot.

INFORMATION

- The use of a cellular phone inside or near the vehicle may cause a noise from the speakers of the audio system which you are listening to. However, this does not indicate a malfunction.

RADIO

Usually, a problem with radio reception does not mean there is a problem with the radio — it is just the normal result of conditions outside the vehicle.

For example, nearby buildings and terrain can interfere with FM reception. Power lines or phone wires can interfere with AM signals. And of course, radio signals have a limited range. The farther the vehicle is from a station, the weaker its signal will be. In addition, reception conditions change constantly as the vehicle moves.

Here, some common reception problems that probably do not indicate a problem with the radio are described.

FM

Fading and drifting stations: Generally, the effective range of FM is about 25 miles (40 km). Once outside this range, you may notice fading and drifting, which increase with the distance from the radio transmitter. They are often accompanied by distortion.

Multi-path: FM signals are reflective, making it possible for 2 signals to reach the vehicle's antenna at the same time. If this happens, the signals will cancel each other out, causing a momentary flutter or loss of reception.

Static and fluttering: These occur when signals are blocked by buildings, trees or other large objects. Increasing the bass level may reduce static and fluttering.

Station swapping: If the FM signal being listened to is interrupted or weakened, and there is another strong station nearby on the FM band, the radio may tune in the second station until the original signal can be picked up again.

AM

Fading: AM broadcasts are reflected by the upper atmosphere — especially at night. These reflected signals can interfere with those received directly from the radio station, causing the radio station to sound alternately strong and weak.

Station interference: When a reflected signal and a signal received directly from a radio station are very nearly the same frequency, they can interfere with each other, making it difficult to hear the broadcast.

Static: AM is easily affected by external sources of electrical noise, such as high tension power lines, lightening or electrical motors. This results in static.

XM

- Cargo loaded on the roof luggage carrier, especially metal objects, may adversely affect the reception of XM Satellite Radio.
- Alternation or modifications carried out without appropriate authorization may invalidate the user's right to operate the equipment.

CD PLAYER AND DISC

- This CD player is intended for use with 4.7 in. (12 cm). discs only.
- Extremely high temperatures can keep the CD player from working. On hot days, use the air conditioning system to cool the inside of the vehicle before using the player.
- Bumpy roads or other vibrations may make the CD player skip.
- If moisture gets into the CD player, the discs may not be able to be played. Remove the discs from the player and wait until it dries.

**CAUTION**

- CD players use an invisible laser beam which could cause hazardous radiation exposure if directed outside the unit. Be sure to operate the player correctly.

Audio CDs



- Use only discs marked as shown above. The following products may not be playable on your player:
 - SACD
 - dts CD
 - Copy-protected CD
 - Video CD

▶ Special shaped discs

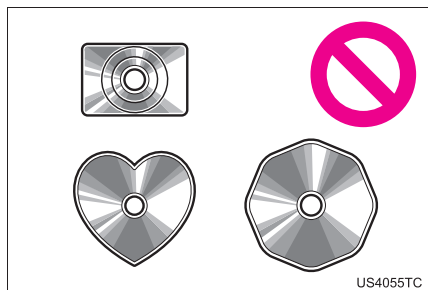

▶ Transparent/translucent discs

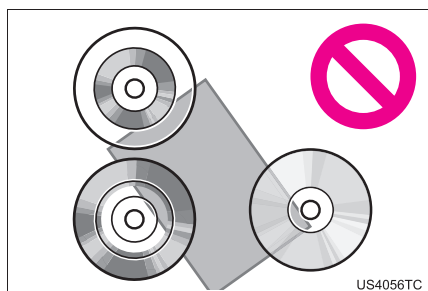

▶ Low quality discs

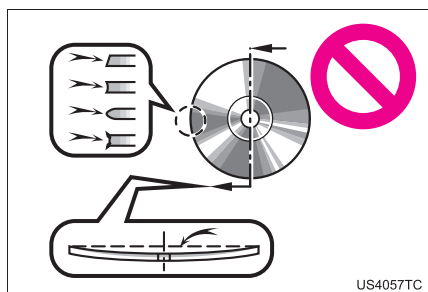

▶ Labeled discs

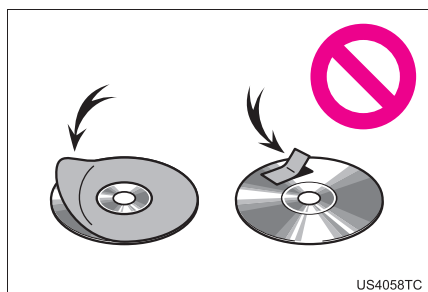

NOTICE

- Do not use special shaped, transparent/translucent, low quality or labeled discs such as those shown in the illustrations. The use of such discs may damage the player, or it may be impossible to eject the disc.
- This system is not designed for use of Dual Discs. Do not use Dual Discs because they may cause damage to the player.
- Do not use discs with a protection ring. The use of such discs may damage the player, or it may be impossible to eject the disc.
- Do not use printable discs. The use of such discs may damage the player, or it may be impossible to eject the disc.

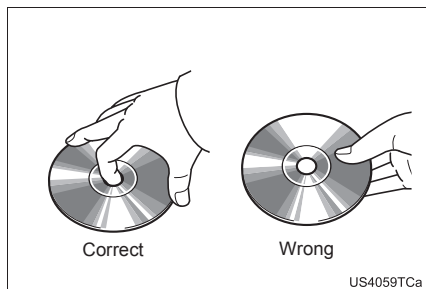

- Handle discs carefully, especially when inserting them. Hold them on the edge and do not bend them. Avoid getting fingerprints on them, particularly on the shiny side.
- Dirt, scratches, warping, pin holes or other disc damage could cause the player to skip or to repeat a section of a track. (To see a pin hole, hold the disc up to the light.)
- Remove discs from the players when not in use. Store them in their plastic cases away from moisture, heat and direct sunlight.

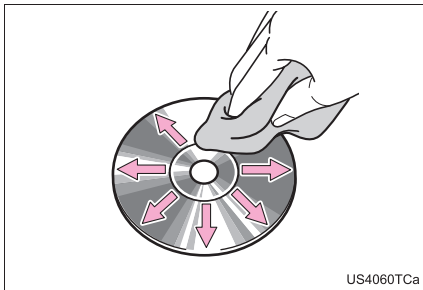

To clean a disc: Wipe it with a soft, lint-free cloth that has been dampened with water. Wipe in a straight line from the center to the edge of the disc (not in circles). Dry it with another soft, lint-free cloth. Do not use a conventional record cleaner or anti-static device.

CD-R/RW DISCS

- CD-R/CD-RW discs that have not been subject to the “finalizing process” (a process that allows discs to be played on a conventional CD player) cannot be played.
- It may not be possible to play CD-R/CD-RW discs recorded on a music CD recorder or a personal computer because of disc characteristics, scratches or dirt on the disc, or dirt, condensation, etc. on the lens of the unit.
- It may not be possible to play discs recorded on a personal computer depending on the application settings and the environment. Record with the correct format. (For details, contact the appropriate application manufacturers of the applications.)
- CD-R/CD-RW discs may be damaged by direct exposure to sunlight, high temperatures or other storage conditions. The unit may be unable to play some damaged discs.
- If you insert a CD-RW disc into the player, playback will begin more slowly than with a conventional CD or CD-R disc.
- Recordings on CD-R/CD-RW cannot be played using the DDCD (Double Density CD) system.

iPod



- “Made for iPod” and “Made for iPhone” mean that an electronic accessory has been designed to connect specifically to iPod or iPhone respectively, and has been certified by the developer to meet Apple performance standards.
- Apple is not responsible for the operation of this device or its compliance with safety and regulatory standards. Please note that the use of this accessory with iPod or iPhone may affect wireless performance.
- iPhone, iPod, iPod classic, iPod nano, and iPod touch are trademarks of Apple Inc., registered in the U.S. and other countries. Lightning is a trademark of Apple Inc.

COMPATIBLE MODELS

The following iPod®, iPod nano®, iPod classic®, iPod touch® and iPhone® devices can be used with this system.

Made for

- iPod touch (5th generation)*
- iPod touch (4th generation)
- iPod touch (3rd generation)
- iPod touch (2nd generation)
- iPod touch (1st generation)
- iPod classic
- iPod with video
- iPod nano (7th generation)*
- iPod nano (6th generation)*
- iPod nano (5th generation)
- iPod nano (4th generation)
- iPod nano (3rd generation)
- iPod nano (2nd generation)*
- iPod nano (1st generation)*
- iPhone 5*
- iPhone 4S
- iPhone 4
- iPhone 3GS
- iPhone 3G
- iPhone

*: iPod video not supported

Depending on differences between models or software versions etc., some models may be incompatible with this system.

FILE INFORMATION

COMPATIBLE USB DEVICES

USB communication formats	USB 2.0 HS (480 Mbps) and FS (12 Mbps)
File formats	FAT 16/32
Correspondence class	Mass storage class

COMPATIBLE COMPRESSED FILES

Item	USB	DISC
Compatible file format	MP3/WMA/AAC	
Folders in the device	Maximum 3000	Maximum 192
Files in the device	Maximum 9999	Maximum 255
Files per folder	Maximum 255	—

CORRESPONDING FREQUENCY SAMPLING

File type	Frequency (kHz)
MP3 files: MPEG 1 LAYER 3	32/44.1/48
MP3 files: MPEG 2 LSF LAYER 3	16/22.05/24
WMA files: Ver. 7, 8, 9 (9.1/9.2)	32/44.1/48
AAC files: MPEG4/AAC-LC	11.025/12/16/ 22.05/24/32/ 44.1/48

CORRESPONDING BIT RATES

File type	Bit rate (kbps)
MP3 files: MPEG 1 LAYER 3	32 - 320
MP3 files: MPEG 2 LSF LAYER 3	8 - 160
WMA files: Ver. 7, 8	CBR 48 - 192
WMA files: Ver. 9 (9.1/9.2)	CBR 48 - 320
AAC files: MPEG4/AAC-LC	16 - 320

(Variable Bit Rate (VBR) compatible)

- MP3 (MPEG Audio Layer 3), WMA (Windows Media Audio) and AAC (Advanced Audio Coding) are audio compression standards.
- This system can play MP3/WMA/AAC files on CD-R, CD-RW discs and USB memory.
- This system can play disc recordings compatible with ISO 9660 level 1 and level 2 and with the Romeo and Joliet file system.
- When naming an MP3/WMA/AAC file, add an appropriate file extension (.mp3/.wma/.m4a).
- This system plays back files with .mp3/.wma/.m4a file extensions as MP3/WMA/AAC files respectively. To prevent noise and playback errors, use the appropriate file extension.
- This system can play only the first session when using multi-session compatible CDs.
- MP3 files are compatible with the ID3 Tag Ver. 1.0, Ver. 1.1, Ver. 2.2 and Ver. 2.3 formats. This system cannot display disc title, track title and artist name in other formats.
- WMA/AAC files can contain a WMA/AAC tag that is used in the same way as an ID3 tag. WMA/AAC tags carry information such as track title and artist name.
- The emphasis function is available only when playing MP3/WMA files recorded at 32, 44.1 and 48 kHz.
- This system can play back AAC files encoded by iTunes.
- The sound quality of MP3/WMA files generally improves with higher bit rates. In order to achieve a reasonable level of sound quality, discs recorded with a bit rate of at least 128 kbps are recommended.
- The MP3/WMA player does not play back MP3/WMA files from discs recorded using packet write data transfer (UDF format). Discs should be recorded using "pre-mastering" software rather than packet-write software.
- M3u playlists are not compatible with the audio player.
- MP3i (MP3 interactive) and MP3PRO formats are not compatible with the audio player.

- The player is compatible with VBR (Variable Bit Rate).
- When playing back files recorded as VBR (Variable Bit Rate) files, the play time will not be correctly displayed if the fast forward or reverse operations are used.
- It is not possible to check folders that do not include MP3/WMA/AAC files.
- MP3/WMA/AAC files in folders up to 8 levels deep can be played. However, the start of playback may be delayed when using discs containing numerous levels of folders. For this reason, we recommend creating discs with no more than 2 levels of folders.

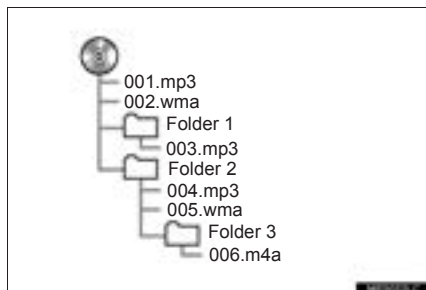

- The play order of the compact disc with the structure shown above is as follows:

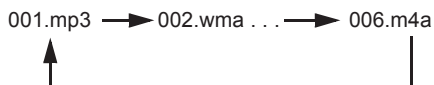

- The order changes depending on the personal computer and MP3/WMA/AAC encoding software you use.

TERMS

PACKET WRITE

- This is a general term that describes the process of writing data on-demand to CD-R, etc., in the same way that data is written to floppy or hard discs.

ID3 TAG

- This is a method of embedding track-related information in an MP3 file. This embedded information can include the track number, track title, the artist's name, the album title, the music genre, the year of production, comments, cover art and other data. The contents can be freely edited using software with ID3 tag editing functions. Although the tags are restricted to a number of characters, the information can be viewed when the track is played back.

WMA TAG

- WMA files can contain a WMA tag that is used in the same way as an ID3 tag. WMA tags carry information such as track title and artist name.

ISO 9660 FORMAT

- This is the international standard for the formatting of CD-ROM folders and files. For the ISO 9660 format, there are 2 levels of regulations.
- Level 1: The file name is in 8.3 format (8 character file names, with a 3 character file extension. File names must be composed of one-byte capital letters and numbers. The “_” symbol may also be included.)
- Level 2: The file name can have up to 31 characters (including the separation mark “.” and file extension). Each folder must contain fewer than 8 hierarchies.

m3u

- Playlists created using “WINAMP” software have a playlist file extension (.m3u).

MP3

- MP3 is an audio compression standard determined by a working group (MPEG) of the ISO (International Standard Organization). MP3 compresses audio data to about 1/10 the size of that on conventional discs.

WMA

- WMA (Windows Media Audio) is an audio compression format developed by Microsoft®. It compresses files into a size smaller than that of MP3 files. The decoding formats for WMA files are Ver. 7, 8 and 9.
- This product is protected by certain intellectual property rights of Microsoft Corporation and third parties. Use or distribution of such technology outside of this product is prohibited without a license from Microsoft or an authorized Microsoft subsidiary and third parties.

AAC

- AAC is short for Advanced Audio Coding and refers to an audio compression technology standard used with MPEG2 and MPEG4.

ERROR MESSAGES

Mode	Message	Explanation
CD	"No music files found."	This indicates that no MP3/WMA/AAC files are included in the disc.
	"Check disc"	It indicates that the disc is dirty, damaged, or it was inserted upside down. Clean the disc or insert it correctly. It indicates a disc which is not playable is inserted.
	"DISC Error"	There is a trouble inside the system. Eject the disc.
USB	"Connection error. Please consult your Owner's Manual for instructions on how to connect the USB device."	This indicates a problem in the USB memory or its connection.
	"There are no files available for playback. Please add compatible files to your USB device."	This indicates that no MP3/WMA/AAC files are included in the USB memory.
iPod	"Connection error. Please consult your Owner's Manual for instructions on how to connect the iPod."	This indicates a problem in the iPod or its connection.
	"There are no songs available for playback. Please add compatible files to your iPod."	This indicates that there is no music data in the iPod.
	"Please check the iPod firmware version."	This indicates that the software version is not compatible. Perform the iPod firmware updates and try again.
	"iPod authorization unsuccessful."	This indicates that it failed to authorize the iPod. Please check your iPod.

INFORMATION

- If the malfunction is not rectified: Take your vehicle to your Toyota dealer.

4

VOICE COMMAND SYSTEM

1 VOICE COMMAND SYSTEM OPERATION

1. **VOICE COMMAND SYSTEM..... 124**
 - USING THE VOICE COMMAND SYSTEM..... 124
 - VOICE COMMAND SYSTEM OPERATION 125
2. **CASUAL SPEECH RECOGNIZATION..... 130**
3. **COMMAND LIST 131**

1

2

3

4

5

6

7

8

9

1. VOICE COMMAND SYSTEM

The voice command system enables the audio, hands-free systems, etc. to be operated using voice commands.

Refer to the command list for samples of voice commands. (→P.131)

USING THE VOICE COMMAND SYSTEM

STEERING SWITCH

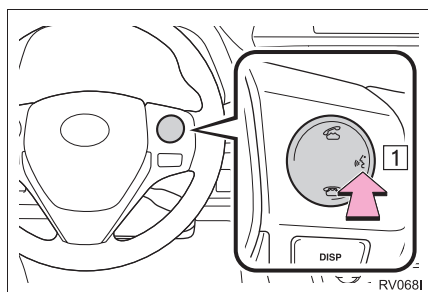

1 Talk switch

- Press the talk switch to start the voice command system.
- To cancel voice recognition, press and hold the talk switch.

MICROPHONE

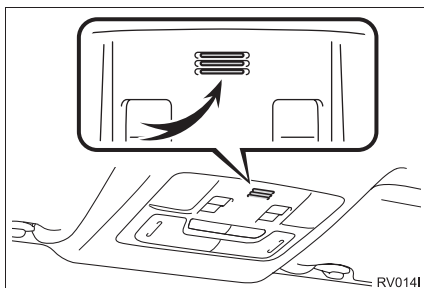

- It is unnecessary to speak directly into the microphone when giving a command.

INFORMATION

- The voice command system can be operated while guidance is being spoken, when “Voice Prompt Interrupt” (→P.59) is set to on. (It is not necessary to wait for the confirmation beep before speaking a command.)
- Voice commands may not be recognized if:
 - Spoken too quickly.
 - Spoken at a low or high volume.
 - The roof or windows are open.
 - Passengers are talking while voice commands are spoken.
 - The air conditioning speed is set high.
 - The air conditioning vents are turned towards the microphone.
- In the following conditions, the system may not recognize the command properly and using voice commands may not be possible:
 - The command is incorrect or unclear. Note that certain words, accents or speech patterns may be difficult for the system to recognize.
 - There is excessive background noise, such as wind noise.

VOICE COMMAND SYSTEM OPERATION

The voice command system is operated by selecting a tab corresponding to each function. The tabs are found on the upper part of the screen.

1 Press the talk switch.

- Voice guidance for the voice command system can be skipped by pressing the talk switch.

2 Say the tab selection command or select the desired tab.

- Commands related with each function are displayed on the screen of the each function tab. Some commonly used commands are displayed on the screen of the function tab.

- Selecting “**Help**” or saying “**Help**” prompts voice guidance to offer examples of commands and operation methods.

3 Say the command displayed on the screen.



- Registered POIs, registered names in the contacts list etc., can be said in the place of the “<>” next to the commands. (→P.131)
For example: Say **“Find nearby dining”**, **“Call John smith”** etc.

- If a desired outcome is not shown, or if no selections are available, perform one of the following to return to the previous screen:
 - Say **“Go back”**.
 - Select **“Go Back”**.
- To cancel voice recognition, select **“Cancel”**, or press and hold the talk switch.

INFORMATION

- If the system does not respond or the confirmation screen does not disappear, press the talk switch and try again.
- “Voice Recognition Prompts” can be set on the “Voice Settings” screen. (→P.59)
- Some voice guidance can be canceled by setting voice prompts to off. Use this setting when it is desirable to say a command immediately after pressing the talk switch and hearing a beep.

■ DISPLAYING THE “Voice Settings” SCREENS



- Selecting **“Voice Settings”** can be displayed the “Voice Settings” screen. (→P.59)

VOICE COMMAND EXAMPLE: LAUNCH Entune App Suite APPLICATION*

- 1** Press the talk switch.
 - 2** Say **“Launch <application name>”**.
- Entune App Suite application screen is displayed.

*: With navigation function

VOICE COMMAND EXAMPLE: PERFORMING A DESTINATION SEARCH BY ADDRESS (ENGLISH ONLY)*

- 1 Press the talk switch.
 - 2 Say **“Enter an address”**.
 - 3 Say **“<house number, street name, city name, State>”** continuously.
 - A confirmation screen will be displayed showing the recognition results. If multiple matching items are found, a selection screen will be displayed. Say **“<number>”** or select the number.
 - Some areas cannot be recognized by the voice recognition system.
- For information regarding the state/province setting to perform a destination search by address: →P.211
- 4 Say **“Go directly”**.
 - After this, follow the voice guidance and search for a destination route by voice command operation.

INFORMATION

- The voice command recognition is designed to recognize the main body of the official street name.

For example: if the official street name is *“East Main Street”*, the voice command recognition will recognize *“Main”*.

- Say the desired number, cardinal direction etc. in the place of the “<>”.

For example: Say **“West 555”**.

- Inputting the house number can be skipped.
- Even if the state set using voice recognition is different from the set state in the “Address” screen (which was set when a destination was set manually), the set state in the “Address” screen will not change. (→P.212)
- The house number voice recognition conditions are outlined below:
 - Numerals: 10 digits or less
 - Numerals and cardinal direction or a hyphen and numerals: A total of 9 digits or less (Do not say **“and”**.)
 - Cardinal direction or a hyphen and numerals: A total of 9 digits or less (Do not say **“and”**.)
 - Numerals are recognized as single digits only.
 - The cardinal direction and hyphens are only recognized once.
 - The following cardinal directions can be recognized: North, East, West and South.

*: With navigation function

VOICE COMMAND EXAMPLE: SEARCH FOR A SONG

- 1 Press the talk switch.
- 2 Say **“Play song <name>”**.
 - A confirmation screen will be displayed showing the recognition results. If multiple matching items are found, a selection screen will be displayed. Say **“<number>”** or select the number.
 - The system starts playing music and the song lists are displayed.

INFORMATION

- The Gracenote database is only compatible with the USB or iPod mode.
- A USB memory or iPod must be connected to enable track searching and playback. (→P.93, 97)
- When a USB memory or iPod is connected, recognition data is created so tracks can be searched using voice commands.
- Recognition data is updated under the following conditions:
 - When the USB memory or iPod data has changed.
 - When the voice recognition language is changed. (→P.53)
- While the recognition data is being created or being updated, a track search cannot be performed using a voice command.

VOICE COMMAND EXAMPLE: CALL NAME

- 1 Press the talk switch.
- 2 Say **“Call <contacts> <phone types>”**.
 - A confirmation screen will be displayed showing the recognition results. If multiple matching items are found, a selection screen will be displayed. Say **“<number>”** or select the number.

INFORMATION

- In the same manner as it is displayed on the screen, **“Call <contacts> <phone types>”**, after saying **“Call a contact”** say the name, or the name and type of phone, of a contact.
For example: **“Call a contact”**, **“John Smith”** or **“Call a contact”**, **“Mary Davis”**, **“Mobile”**
- There are 4 types of phones: Home, Mobile, Work and Other.
- Short or abbreviated names in the contacts list may not be recognized. Change names in the contacts list to full names.
- Sometimes a voice recognition result confirmation screen will be displayed. After confirming the result, say **“Yes”** or **“No”**.
- When the system recognizes multiple names from the contacts list, a name candidate list will be displayed on the screen. If the desired name is not displayed on the top of the screen, say or select the number of the name from the candidate list (number 1, number 2, etc.) to select a name from the candidate list.
- When a contact has multiple phone numbers registered in the contacts list, a candidate list will be displayed. If the desired phone number is not displayed on the top of the screen, say or select the number of the desired phone number from the candidate list (number 1, number 2, etc.) to select a phone number from the candidate list.

VOICE COMMAND EXAMPLE: DIAL NUMBER

- 1 Press the talk switch.
- 2 Say the phone number.
 - In the same manner as it is displayed on the screen, "Dial <number>", after saying "**Dial a number**" say the phone number.
 - Say the phone number one digit at a time. For example, if the phone number is 2345678:
Say "**two three four five six seven eight**"
Do not say "**twenty three forty five sixty seven eight**"
- ▶ Calling to the following phone numbers
 - 3 digit numbers (911, 411, 611)
 - 7 digit numbers (Local phone numbers)
 - 10 digit numbers (Area code + Local phone number)
 - 11 digit phone numbers (1 + Area code + Local phone number)
- As the system cannot recognize additional numbers, say the complete number without stopping.
- ▶ Calling to other phone numbers
- 3 Say "**Call**" or press the  switch on the steering wheel.

- When the system recognizes multiple phone numbers, a phone number candidate list will be displayed on the screen. Pressing the  switch on the steering wheel makes a call to the top entry on the list. If the desired phone number is not displayed on the top of the screen, say the number of the desired phone number from the candidate list to select a phone number from the candidate list.

2. CASUAL SPEECH RECOGNITION

Due to natural language speech recognition technology, this system enables recognition of a command when spoken naturally. However, the system cannot recognize every variation of each command. In some situations, it is possible to omit the command for the procedure and directly state the desired operation. Not all voice commands are displayed in the function menu.

INFORMATION

- If the command cannot be recognized completely, the command input screen will be displayed. (Search results will be shown based on the part of the command that was recognized.)

EXPRESSION EXAMPLES FOR EACH FUNCTION

Command	Expression examples
"Go Home"*	<i>Navigate to my house. Take me home.</i>
"Enter an Address"*	<i>I need directions to an address. Give me a street.</i>
"Find Nearby <POI category>"*	<i>Search for a <Restaurants> around here. Find a <Restaurants> nearby.</i>
"Call <name> <type>"	<i>Get me <Robert Brown>. Call <contacts> <phonetypes>.</i>
"Dial <number>"	<i>Call <911>.</i>
"Play Artist <name>"	<i>Play the artist <name>. I want to hear the band <name>.</i>
"Play Album <name>"	<i>Play album <name>. Play album <albums>.</i>

*: With navigation function

3. COMMAND LIST

Recognizable voice commands and their actions are shown below.

- Frequently used commands are listed in the following tables.
- For devices that are not installed in the vehicle, the related commands will not be displayed in the screen. Also, according to conditions, other commands may not be displayed in the screen.
- The functions available may vary according to the system installed.

- Voice recognition language can be changed. (→P.53)

▶ Basic

Command	Action
"Help with <function name*>"	Prompts voice guidance to offer examples of commands or operation methods
"Go Back"	Returns to the previous screen
"Number one/two/three/four/five"	Selects the number on the list screen
"Next Page"	Displays the next page
"Previous Page"	Displays the previous page
"Go to <tab>"	Displays the command list of the selected tab

*: For example; "Music", "Phone", etc.

▶ Apps*¹

When the voice recognition language is set to English.

Command	Action
"Launch <apps>"	Activates the Entune App Suite application

▶ Navigation*¹

Command	Action
"Find Nearby <POI category*>"	Displays a list of <POI category* ² > near the current position
"Enter an Address"	Enables setting a destination by saying the address
"Go Home"	Displays the route to home
"Cancel Route"	Stops the route guidance

*¹: With navigation function

*²: For example; "Gas stations", "Restaurants", etc.

▶ Phone

Command	Action
“Redial”	Places a call to the phone number of the latest outgoing call
“Call Back”	Places a call to the phone number of latest incoming call
“Show Recent Calls”	Displays the call history screen
“Dial <phone number>”	Places a call to the said phone number
“Call <contacts> <phonetypes>”	Place a call to the said phone type of the contact from the phone book

▶ Audio

Command	Action
“Play Playlist <name>”	Plays tracks from the selected playlist
“Play Artist <name>”	Plays tracks from the selected artist
“Play Song <name>”	Plays the selected track
“Play Album <name>”	Plays tracks from the selected album

▶ Information*

Command	Action
“Show Forecast”	Displays weather information
“Show Traffic”	Displays traffic information

*: Except for Mexico

INFORMATION

- Commands relating to operation of the audio can only be performed when the audio is turned on.

5

INFORMATION

1 USEFUL INFORMATION

1. RECEIVING WEATHER INFORMATION 134
DISPLAYING WEATHER INFORMATION 134
2. RECEIVING TRAFFIC MAP INFORMATION 136
DISPLAYING TRAFFIC MAP INFORMATION 136
3. DATA SERVICES SETTINGS 137
SETTING DOWNLOAD METHODS 137

1

2

3

4

5

6

7

8

9

1. RECEIVING WEATHER INFORMATION

▶ Without navigation function
Weather information can be received via the HD Radio.

▶ With navigation function
Weather information can be received via the HD Radio or by the Entune App Suite application on a Bluetooth® phone. For details about the Entune App Suite application: →P.263

DISPLAYING WEATHER INFORMATION

1 Press the “**APPS**” button.

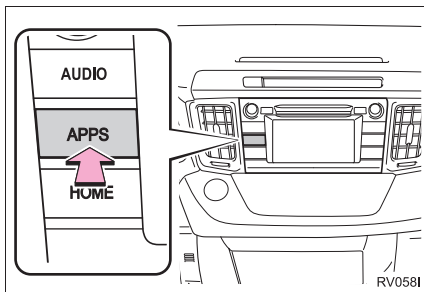

2 Select “**Weather**”.

3 Check that the “Weather” screen is displayed.



No.	Function
1	Select to display the weather of the current location. (→P.135)
2	Select to display the weather of a desired location in the recently checked locations list.
3	Select to display the weather of a desired location in the national cities list.
4	Select to display the weather of a desired location in the other local cities list.
5*	Select to display weather information over the map.

*: With navigation function

INFORMATION

- Weather information is available in the 48 states, D.C. and Alaska of the United States.

DISPLAYING THE WEATHER OF THE CURRENT LOCATION

- 1 Display the “Weather” screen.
(→P.134)
- 2 Select “**Current Weather**”.
- 3 Select the desired tab to be displayed.

INFORMATION

- If weather is set to the home screen, the weather screen of the current location will be displayed.

2. RECEIVING TRAFFIC MAP INFORMATION*

Traffic map information can be received via the HD Radio.

DISPLAYING TRAFFIC MAP INFORMATION

- 1 Press the “APPS” button.

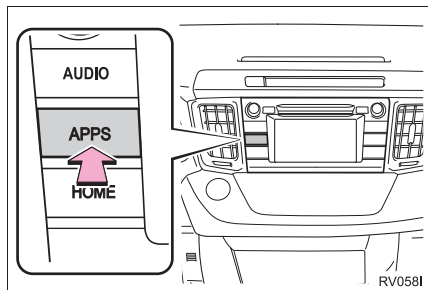

- 2 Select “Traffic”.

- 3 Check that the “Traffic Map” screen is displayed.



No.	Function
1	Current position of your car
2	Traffic information line The line color means the following: Red: Heavy congestion Yellow: Moderate traffic Green: Freely flowing traffic

INFORMATION

- Traffic map information is available in the 48 states, D.C. and Alaska of the United States.

*: Without navigation function

3. DATA SERVICES SETTINGS*

SETTING DOWNLOAD METHODS

Data service information, which is comprised of traffic information and weather information, can be received via the HD Radio and by the Entune App Suite application on a Bluetooth® phone. The receiving method can be set to both or only via the HD Radio. For details about the Entune App Suite application: →P.263

- 1 Press the “**APPS**” button.

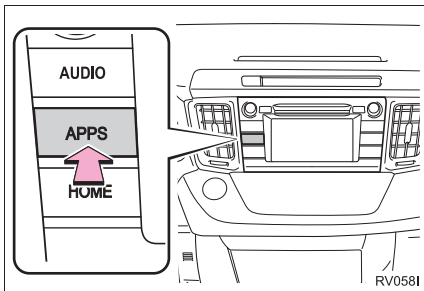

- 2 Select “**Setup**”.
- 3 Select “**HD Data**”.

- 4 Select the desired item to be set.

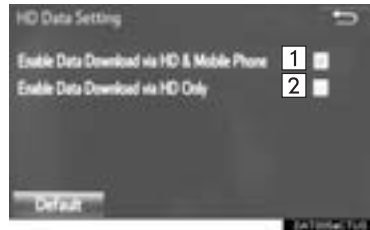

- Select a checkbox on the right to set.

No.	Function
1	Select to receive data service information via both the HD Radio and the Entune App Suite application on a Bluetooth® phone. When both methods are available, the HD Radio will be selected.
2	Select to receive data only via the HD Radio.

INFORMATION

- These settings are available in the 48 states, D.C. and Alaska of the United States.

*: With navigation function

6

PERIPHERAL MONITORING SYSTEM

1 REAR VIEW MONITOR SYSTEM

1. **REAR VIEW MONITOR SYSTEM** 140
 - REAR VIEW MONITOR SYSTEM..... 140
 - DRIVING PRECAUTIONS 140
 - SCREEN DESCRIPTION 142
2. **REAR VIEW MONITOR SYSTEM PRECAUTIONS** 144
 - AREA DISPLAYED ON SCREEN..... 144
 - THE CAMERA 144
 - DIFFERENCES BETWEEN THE SCREEN AND THE ACTUAL ROAD 145
 - WHEN APPROACHING THREE-DIMENSIONAL OBJECTS 147
3. **THINGS YOU SHOULD KNOW** 149
 - IF YOU NOTICE ANY SYMPTOMS 149

1. REAR VIEW MONITOR SYSTEM

REAR VIEW MONITOR SYSTEM

The rear view monitor system assists the driver by displaying an image of the view behind the vehicle with fixed guide lines on the screen while backing up, for example while parking.

INFORMATION

- The screen illustrations used in this text are intended as examples, and may differ from the image that is actually displayed on the screen.

DRIVING PRECAUTIONS

The rear view monitor system is a supplemental device intended to assist the driver when backing up. When backing up, be sure to visually check all around the vehicle both directly and using the mirrors before proceeding. If you do not, you may hit another vehicle, and could possibly cause an accident.

Pay attention to the following precautions when using the rear view monitor system.

**CAUTION**

- Never depend on the rear view monitor system entirely when backing up. The image and the position of the guide lines displayed on the screen may differ from the actual state.
Use caution, just as you would when backing up any vehicle.
- Be sure to back up slowly, depressing the brake pedal to control vehicle speed.
- The instructions given are only guidelines. When and how much to turn the steering wheel will vary according to traffic conditions, road surface conditions, vehicle condition, etc. when parking. It is necessary to be fully aware of this before using the rear view monitor system.
- When parking, be sure to check that the parking space will accommodate your vehicle before maneuvering into it.

**CAUTION**

- Do not use the rear view monitor system in the following cases:
 - On icy or slick road surfaces, or in snow
 - When using tire chains or emergency tires
 - When the back door is not closed completely
 - On roads that are not flat or straight, such as curves or slopes.
- In low temperatures, the screen may darken or the image may become faint. The image could distort when the vehicle is moving, or you may become unable to see the image on the screen. Be sure to visually check all around the vehicle both directly and using the mirrors before proceeding.
- If the tire sizes are changed, the position of the fixed guide lines displayed on the screen may change.
- The camera uses a special lens. The distances between objects and pedestrians that appear in the image displayed on the screen will differ from the actual distances. (→P.145)

SCREEN DESCRIPTION

► Vehicles without a smart key system

The rear view monitor system screen will be displayed if the shift lever is shifted to the “R” position while the engine switch is in “ON” position.

► Vehicles with a smart key system

The rear view monitor system screen will be displayed if the shift lever is shifted to the “R” position while the engine switch is in IGNITION ON mode.

Guide lines are displayed on the screen.

Guide lines shown differ from those shown on the actual screen.

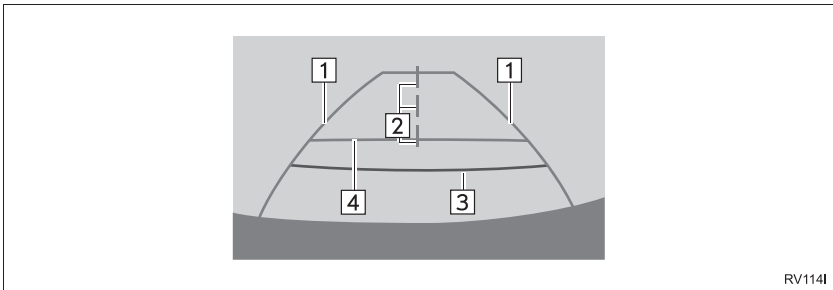

RV114I

No.	Display	Function
1	Vehicle width extension guide lines	Displays a guide path when the vehicle is being backed straight up. <ul style="list-style-type: none"> The displayed width is wider than the actual vehicle width.
2	Vehicle center guide lines	These lines indicate the estimated vehicle center on the ground.
3	Distance guide lines	Shows distance behind the vehicle. <ul style="list-style-type: none"> Displays a point approximately 1.5 ft. (0.5 m) (red) from the edge of the bumper.
4	Distance guide line	Shows distance behind the vehicle. <ul style="list-style-type: none"> Displays a point approximately 3 ft. (1 m) (blue) from the edge of the bumper.

CANCELING REAR VIEW MONITOR SYSTEM

The rear view monitor system is canceled when the shift lever is shifted into any position other than the “R” position.

2. REAR VIEW MONITOR SYSTEM PRECAUTIONS

AREA DISPLAYED ON SCREEN

The rear view monitor system displays an image of the view from the bumper of the rear area of the vehicle.

Displayed area

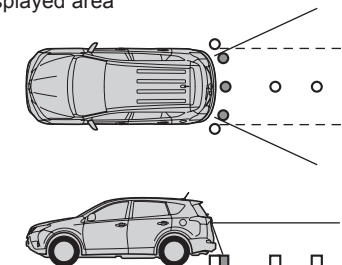

Screen

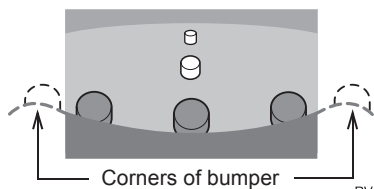

- The image adjustment procedure for the rear view monitor system screen is the same as the procedure for adjusting the navigation screen. (→P.40)

INFORMATION

- The area displayed on the screen may vary according to vehicle orientation conditions.
- Objects which are close to either corner of the bumper or under the bumper cannot be displayed.
- The camera uses a special lens. The distance of the image that appears on the screen differs from the actual distance.
- Items which are located higher than the camera may not be displayed on the monitor.

THE CAMERA

The camera for the rear view monitor system is located as shown in the illustration.

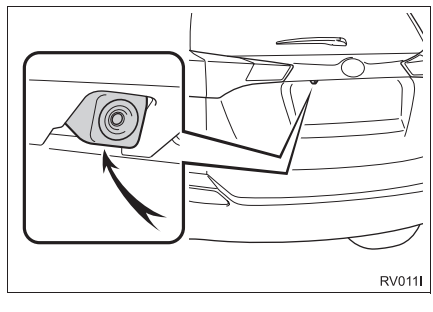

USING THE CAMERA

If the camera lens becomes dirty, it cannot transmit a clear image. If water droplets, snow or mud adhere to the lens, rinse with water and wipe with a soft cloth. If the lens is extremely dirty, wash it with a mild cleanser and rinse.

**NOTICE**

- The rear view monitor system may not operate properly in the following cases.
 - If the back of the vehicle is hit, the position and mounting angle of the camera may change.
 - As the camera has a water proof construction, do not detach, disassemble or modify it. This may cause incorrect operation.
 - Do not strongly rub the camera lens. If the camera lens is scratched, it cannot transmit a clear image.
 - Do not allow organic solvent, car wax, window cleaner or glass coat to adhere to the camera. If this happens, wipe it off as soon as possible.
 - If the temperature changes rapidly, such as when hot water is poured on the vehicle in cold weather, the system may not operate normally.
 - When washing the vehicle, do not apply intensive bursts of water to the camera or camera area. Doing so may result in the camera malfunctioning.
- Do not expose the camera to strong impact as this could cause a malfunction. If this happens, have the vehicle inspected by your Toyota dealer as soon as possible.

DIFFERENCES BETWEEN THE SCREEN AND THE ACTUAL ROAD

- The distance guide lines and the vehicle width extension guide lines may not actually be parallel with the dividing lines of the parking space, even when they appear to be so. Be sure to check visually.
- The distances between the vehicle width extension guide lines and the left and right dividing lines of the parking space may not be equal, even when they appear to be so. Be sure to check visually.
- The distance guide lines give a distance guide for flat road surfaces. In any of the following situations, there is a margin of error between the fixed guide lines on the screen and the actual distance/course on the road.

WHEN THE GROUND BEHIND THE VEHICLE SLOPES UP SHARPLY

The distance guide lines will appear to be closer to the vehicle than the actual distance. Because of this, objects will appear to be farther away than they actually are. In the same way, there will be a margin of error between the guidelines and the actual distance/course on the road.

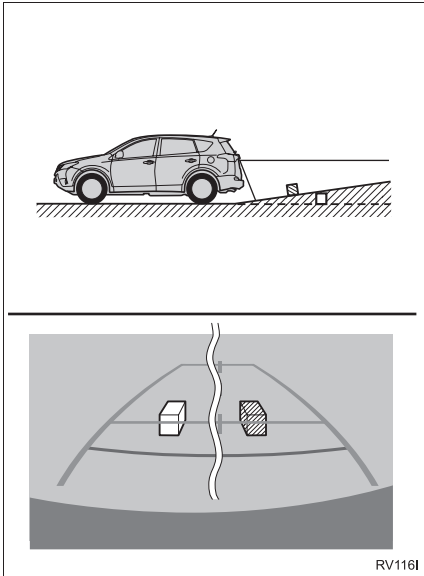

WHEN THE GROUND BEHIND THE VEHICLE SLOPES DOWN SHARPLY

The distance guide lines will appear to be further from the vehicle than the actual distance. Because of this, objects will appear to be closer than they actually are. In the same way, there will be a margin of error between the guidelines and the actual distance/course on the road.

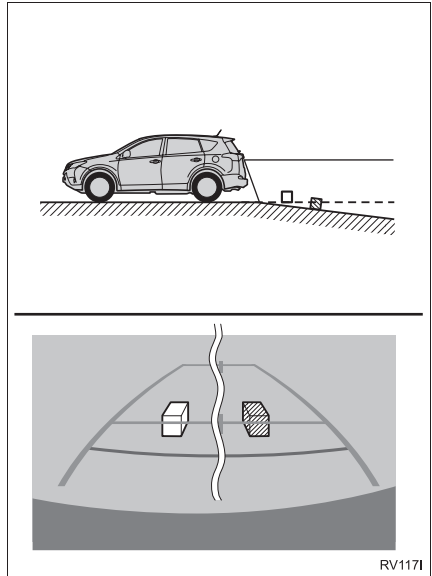

WHEN ANY PART OF THE VEHICLE SAGS

When any part of the vehicle sags due to the number of passengers or the distribution of the load, there is a margin of error between the fixed guide lines on the screen and the actual distance/course on the road.

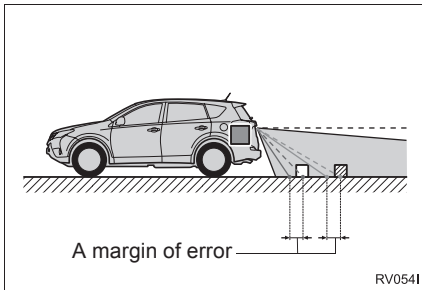

WHEN APPROACHING THREE-DIMENSIONAL OBJECTS

The distance guide lines are displayed according to flat surfaced objects (such as the road). It is not possible to determine the position of three-dimensional objects (such as vehicles) using the distance guide lines. When approaching a three-dimensional object that extends outward (such as the flat-bed of a truck), be careful of the following.

VEHICLE WIDTH EXTENSION GUIDE LINES

Visually check the surroundings and the area behind the vehicle. In the case shown below, the truck appears to be outside of the vehicle width extension guide lines and the vehicle does not look as if it hits the truck. However, the rear body of the truck may actually cross over the vehicle width extension guide lines. In reality if you back up as guided by the vehicle width extension guide lines, the vehicle may hit the truck.

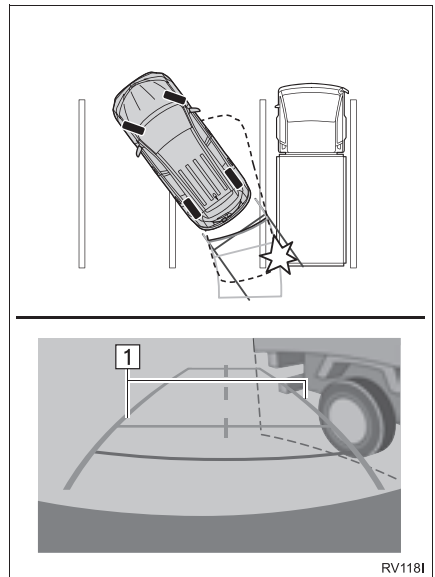

▶ 1 Vehicle width extension guide lines

DISTANCE GUIDE LINES

Visually check the surroundings and the area behind the vehicle. On the screen, it appears that a truck is parking at point B. However, in reality if you back up to point A, you will hit the truck. On the screen, it appears that A is closest and C is furthest away. However, in reality, the distance to A and C is the same, and B is farther than A and C.

Positions of A, B and C

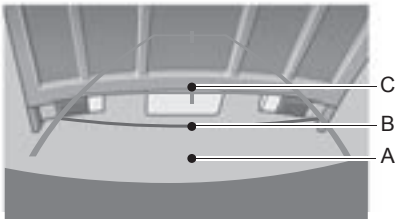
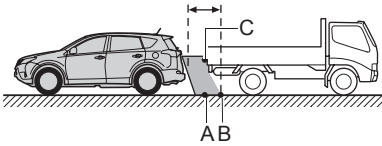

RV119I

3. THINGS YOU SHOULD KNOW

IF YOU NOTICE ANY SYMPTOMS

If you notice any of the following symptoms, refer to the likely cause and the solution, and re-check.

If the symptom is not resolved by the solution, have the vehicle inspected by your Toyota dealer.

Symptom	Likely cause	Solution
The image is difficult to see	<ul style="list-style-type: none"> • The vehicle is in a dark area • The temperature around the lens is either high or low • The outside temperature is low • There are water droplets on the camera • It is raining or humid • Foreign matter (mud etc.) is adhering to the camera • Sunlight or headlights are shining directly into the camera • The vehicle is under fluorescent lights, sodium lights, mercury lights etc. 	<p>Back up while visually checking the vehicle's surroundings. (Use the monitor again once conditions have been improved.)</p> <p>The procedure for adjusting the picture quality of the rear view monitor system is the same as the procedure for adjusting the navigation screen. (→P.40)</p>
The image is blurry	Dirt or foreign matter (such as water droplets, snow, mud etc.) is adhering to the camera.	<p>Rinse the camera lens with water and wipe it clean with a soft cloth.</p> <p>Wash with a mild soap if the dirt is stubborn.</p>
The image is out of alignment	The camera or surrounding area has received a strong impact.	Have the vehicle inspected by your Toyota dealer.
The fixed guide lines are very far out of alignment	The camera position is out of alignment.	Have the vehicle inspected by your Toyota dealer.
	<ul style="list-style-type: none"> • The vehicle is tilted (there is a heavy load on the vehicle, tire pressure is low due to a tire puncture, etc.) • The vehicle is used on an incline. 	<p>If this happens due to these causes, it does not indicate a malfunction.</p> <p>Back up while visually checking the vehicle's surroundings.</p>

PHONE

1 PHONE OPERATION (HANDS-FREE SYSTEM FOR CELLULAR PHONES)

- 1. **QUICK REFERENCE** 152
- 2. **SOME BASICS** 153
 - REGISTERING/CONNECTING A
Bluetooth® PHONE 153
 - USING THE PHONE
SWITCH/MICROPHONE 154
 - VOICE COMMAND SYSTEM..... 154
 - ABOUT THE CONTACTS IN THE
CONTACT LIST 155
 - WHEN SELLING OR DISPOSING
OF THE VEHICLE..... 155
- 3. **CALLING ON THE Bluetooth®
PHONE**..... 156
 - BY FAVORITES LIST 157
 - BY CALL HISTORY 157
 - BY CONTACTS LIST 158
 - BY DIAL PAD 160
 - BY OFF HOOK SWITCH 160
 - BY "Home" SCREEN 161
- 4. **RECEIVING ON THE
Bluetooth® PHONE**..... 162
 - INCOMING CALLS 162
- 5. **TALKING ON THE
Bluetooth® PHONE**..... 163
 - INCOMING CALL WAITING 165

- 6. **Bluetooth® PHONE MESSAGE
FUNCTION** 166
 - RECEIVING A MESSAGE 167
 - CHECKING MESSAGES 167
 - REPLYING TO A MESSAGE
(QUICK REPLY)..... 168
 - CALLING THE MESSAGE
SENDER 169



2 SETUP

- 1. **PHONE/MESSAGE
SETTINGS** 171
 - PHONE/MESSAGE SETTINGS
SCREEN 171
 - "Sound Settings" SCREEN 172
 - "Contact/Call History Settings"
SCREEN 173
 - "Messaging Settings" SCREEN 181
 - "Phone Display Settings"
SCREEN 182

3 WHAT TO DO IF...

- 1. **TROUBLESHOOTING** 183

1. QUICK REFERENCE

The phone top screen can be used to make a phone call. To display the hands-free operation screen, press the “**APPS**” button and select “**Phone**”, the  switch on the steering wheel or  switch on the instrument panel.

Several functions are available to operate on each screen that is displayed by selecting the 4 tabs.

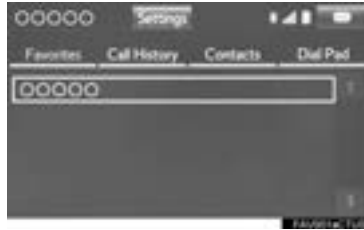

	Function	Page
Phone operation	Registering/connecting Bluetooth® phone	42
	Calling on the Bluetooth® phone	156
	Receiving on the Bluetooth® phone	162
	Talking on the Bluetooth® phone	163
Message function	Using the Bluetooth® phone message function	166
Setting up a phone	Phone settings	171
	Bluetooth® settings	45

2. SOME BASICS

The hands-free system enables calls to be made and received without having to take your hands off the steering wheel.

This system supports Bluetooth®. Bluetooth® is a wireless data system that enables cellular phones to be used without being connected by a cable or placed in a cradle.

The operating procedure of the phone is explained here.

**CAUTION**

- While driving, do not use a cellular phone or connect the Bluetooth® phone.
- Your audio unit is fitted with Bluetooth® antennas. People with implantable cardiac pacemakers, cardiac resynchronization therapy-pacemakers or implantable cardioverter defibrillators should maintain a reasonable distance between themselves and the Bluetooth® antennas. The radio waves may affect the operation of such devices.
- Before using Bluetooth® devices, users of any electrical medical device other than implantable cardiac pacemakers, cardiac resynchronization therapy-pacemakers or implantable cardioverter defibrillators should consult the manufacturer of the device for information about its operation under the influence of radio waves. Radio waves could have unexpected effects on the operation of such medical devices.

**NOTICE**

- Do not leave your cellular phone in the vehicle. The temperature inside may rise to a level that could damage the phone.

INFORMATION

- If your cellular phone does not support Bluetooth®, this system cannot function.
- In the following conditions, the system may not function:
 - The cellular phone is turned off.
 - The current position is outside the communication area.
 - The cellular phone is not connected.
 - The cellular phone has a low battery.
- When using Bluetooth® audio and hands-free at the same time, the following problems may occur:
 - The Bluetooth® connection may be cut.
 - Noise may be heard on the Bluetooth® audio playback.

REGISTERING/CONNECTING A Bluetooth® PHONE

To use the hands-free system for cellular phones, it is necessary to register a cellular phone with the system. (→P.42)

Bluetooth® PHONE CONDITION DISPLAY

The condition of the Bluetooth® phone appears on the upper right side of the screen. (→P.18)

USING THE PHONE SWITCH/ MICROPHONE

► Steering switch

By pressing the phone switch, a call can be received or ended without taking your hands off the steering wheel.

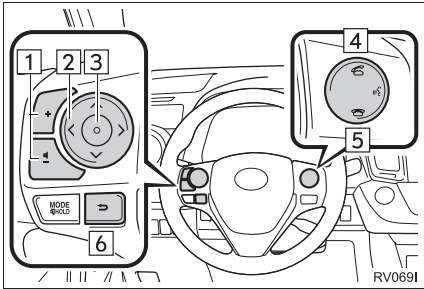

- 1 Volume control switches
 - Press the “+” side to increase the volume.
 - Press the “-” side to decrease the volume.
- 2 “^ v > <” switch
 - Press the “^” or “v” switch to change item.
 - Press the “>” or “<” switch to change selected tabs.
- 3 Enter switch
 - Press the enter switch to execute.
- 4 Off hook switch
- 5 On hook switch
- 6 Back switch
 - Press the back switch to return to the previous screen.

► Microphone

The microphone is used when talking on the phone.

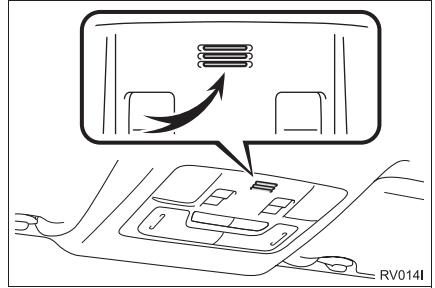

VOICE COMMAND SYSTEM

Press this switch to operate the voice command system.

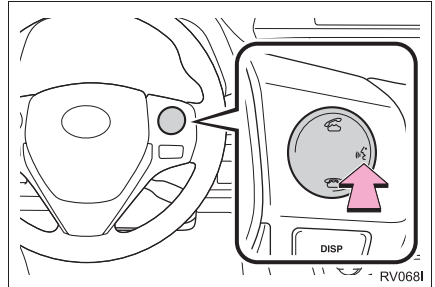

- The voice command system and its list of commands can be operated. (→P.124)

INFORMATION

- The other party's voice will be heard from the front speakers. The audio system will be muted during phone calls or when hands-free voice commands are used.
- Talk alternately with the other party on the phone. If both parties speak at the same time, the other party may not hear what has been said. (This is not a malfunction.)
- Keep call volume down. Otherwise, the other party's voice may be audible outside the vehicle and voice echo may increase. When talking on the phone, speak clearly towards the microphone.
- The other party may not hear you clearly when:
 - Driving on an unpaved road. (Making excessive traffic noise.)
 - Driving at high speeds.
 - The roof or windows are open.
 - The air conditioning vents are pointed towards the microphone.
 - The sound of the air conditioning fan is loud.
 - There is a negative effect on sound quality due to the phone and/or network being used.

ABOUT THE CONTACTS IN THE CONTACT LIST

- The following data is stored for every registered phone. When another phone is connected, the following registered data cannot be read:
 - Contact data
 - Call history data
 - Favorites data
 - Image data
 - All phone settings
 - Message settings

INFORMATION

- When a phone's registration is deleted, the above-mentioned data is also deleted.

WHEN SELLING OR DISPOSING OF THE VEHICLE

A lot of personal data is registered when the hands-free system is used. When selling or disposing of the vehicle, initialize the data. (→P.58)

- The following data in the system can be initialized:
 - Contact data
 - Call history data
 - Favorites data
 - Image data
 - All phone settings
 - Message settings

INFORMATION

- Once initialized, the data and settings will be erased. Pay much attention when initializing the data.

3. CALLING ON THE Bluetooth® PHONE

After a Bluetooth® phone has been registered, a call can be made using the hands-free system. There are several methods by which a call can be made, as described below.

1 Press the “APPS” button.

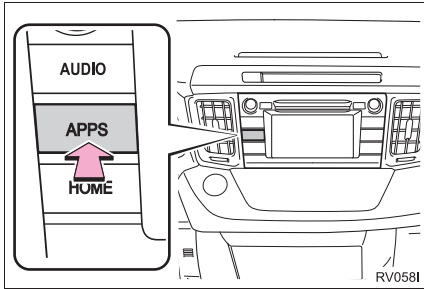

2 Select “Phone”.

3 Select the desired tab to call from.

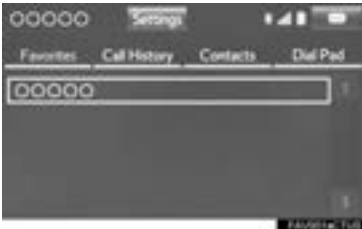

- The phone top screen can be displayed by pressing the switch on the steering wheel or switch on the instrument panel.

How to make a call list	Page
By favorites list	157
By call history	157
By contacts list* ¹	158
By dial pad* ¹	160
By e-mail/SMS/MMS	169
By POI call* ²	203
By off hook switch	160
By Entune App Suite* ^{1, 2}	270
By voice command system	128
By “Home” screen	161

*1: The operation cannot be performed while driving.

*2: With navigation function

BY FAVORITES LIST

Calls can be made using registered contacts which can be selected from a contact list. (→P.178)

- 1 Display the phone top screen. (→P.156)
- 2 Select the **“Favorites”** tab and select the desired contact.

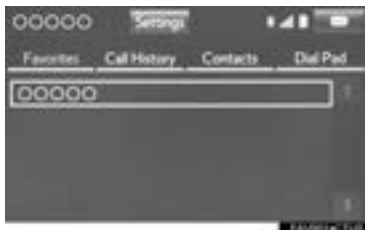

- 3 Select the desired number.
- 4 Check that the “Call” screen is displayed.

BY CALL HISTORY

Up to 30 of the latest call history items (missed, incoming and outgoing) can be selected from the “Call History” tab.

- 1 Display the phone top screen. (→P.156)
- 2 Select the **“Call History”** tab and select  or the desired contact.

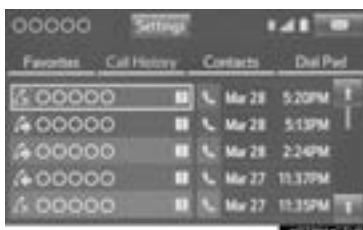

- The icons of call type are displayed.



: Missed call



: Incoming call



: Outgoing call

- ▶ When  is selected

- 3 Check that the “Call” screen is displayed.
- ▶ When the desired contact is selected
- 3 Select the desired number.
- 4 Check that the “Call” screen is displayed.

INFORMATION

- When making a call to the same number continuously, only the most recent call is listed in call history.
- When a phone number registered in the contact list is received, the name is displayed.
- Number-withheld calls are also memorized in the system.
- International phone calls may not be made depending on the type of cellular phone you have.
- The list should group together consecutive entries with the same phone number and same call type. For example, two calls from Kay Rowles's mobile would be displayed as follows: Kay Rowles (2)
- By pressing the  switch on the steering wheel, a call to the latest history item can be made.

BY CONTACTS LIST

Calls can be made by using contact data which is transferred from a registered cellular phone. (→P.159)

Up to 2500 contacts (maximum of 4 phone numbers and e-mail addresses per contact) can be registered in the contact list.

- 1 Display the phone top screen. (→P.156)
- 2 Select the **“Contacts”** tab and select the desired contact.

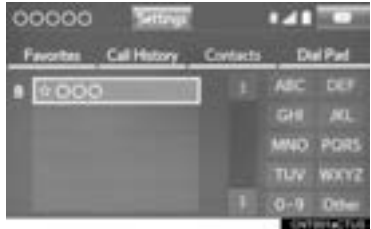

- 3 Select the desired number.
- 4 Check that the **“Call”** screen is displayed.

WHEN THE CONTACT IS EMPTY

FOR PBAP COMPATIBLE Bluetooth® PHONES

- ▶ When “Automatic Transfer” is set to on (→P.173)
- Contacts are transferred automatically.
- ▶ When “Automatic Transfer” is set to off (→P.173)

- 1 Select the desired item.

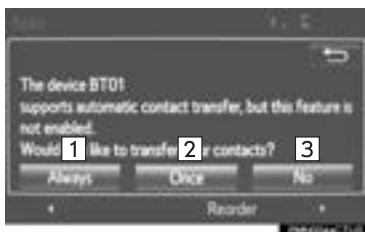

No.	Function
1	Select to transfer new contacts from a cellular phone, select “Always” and then enable “Automatic Transfer”.
2	Select to transfer all the contacts from a connected cellular phone only once.
3	Select to cancel transferring.

FOR PBAP INCOMPATIBLE BUT OPP COMPATIBLE Bluetooth® PHONES

- 1 Select the desired item.

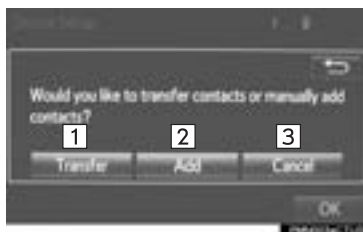

No.	Function
1	Select to transfer the contacts from the connected cellular phone.
2	Select to add a new contact manually.
3	Select to cancel transferring.



- ▶ When “Transfer” is selected
- 2 Follow the steps in “FOR PBAP INCOMPATIBLE BUT OPP COMPATIBLE Bluetooth® PHONES” from “STEP 2”. (→P.174)
- ▶ When “Add” is selected
- 2 Follow the steps in “REGISTERING A NEW CONTACT TO THE CONTACT LIST” from “STEP 2”. (→P.175)

INFORMATION

- Manual transfer operation cannot be performed while driving.
- If your cellular phone is neither PBAP nor OPP compatible, the contacts cannot be transferred.
- Depending on the type of Bluetooth® phone:
 - It may be necessary to perform additional steps on the phone when transferring contact data.
 - The registered image in the contact list may not transfer depending on the type of Bluetooth® phone connected.

BY OFF HOOK SWITCH



Calls can be made using the latest call history item.

- 1 Press the  switch on the steering wheel to display the phone top screen.
- 2 Press the  switch on the steering wheel to display the “Call History” screen.
- 3 Press the  switch on the steering wheel to call the latest history item.
- 4 Check that the “Call” screen is displayed.

BY DIAL PAD

- 1 Display the phone top screen. (→P.156)
- 2 Select the “Dial Pad” tab and enter the phone number.



- 3 Select  or press the  switch on the steering wheel.
- 4 Check that the “Call” screen is displayed.

INFORMATION

- Depending on the type of Bluetooth® phone being connected, it may be necessary to perform additional steps on the phone.

BY “Home” SCREEN

- 1 Display the home screen. (→P.36)
- 2 Select the desired contact.



- 3 Check that the “Call” screen is displayed.

REGISTERING A NEW CONTACT

- 1 Select and hold the screen button to add a contact.
- 2 Select the desired contact.
- 3 Select the desired number.



INFORMATION

- If there is no contact in the contacts list, the contacts cannot be registered at the home screen.
- The contact cannot be registered at the home screen while driving.

4. RECEIVING ON THE Bluetooth® PHONE



INCOMING CALLS

When a call is received, this screen is displayed with a sound.

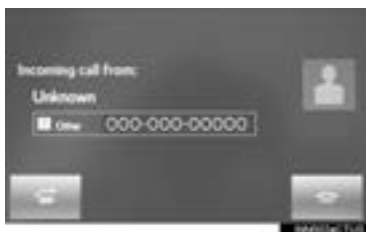
- 1 Select  or press the  switch on the steering wheel to talk on the phone.



To refuse to receive the call: Select

 or press the  switch on the steering wheel.

To adjust the volume of a received call:

Turn the “PWR VOL” knob, or use the volume control switch on the steering wheel.

INFORMATION

- During international phone calls, the other party's name or number may not be displayed correctly depending on the type of cellular phone you have.
- The incoming call display mode can be set. (→P.182)
- The ringtone that has been set in the “Sound Settings” screen sounds when there is an incoming call. Depending on the type of Bluetooth® phone, both the system and Bluetooth® phone may sound simultaneously when there is an incoming call. (→P.172)

5. TALKING ON THE Bluetooth® PHONE

While talking on the phone, this screen is displayed. The operations outlined below can be performed on this screen.

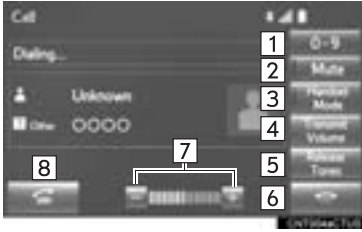

No.	Function	Page
1	Select to display the dial pad to send tones.	163
2	Select to mute your voice to the other party.	—
3	Select to change handset modes between hands-free and cellular phone.	—
4	Select to adjust your voice volume that the other party hears from their speaker.	164
5	Select to send tones. This button only appears when a number that contains a (w) is dialed in hands-free mode.	164
6	Select to hang up the phone.	—
7	Select “+” or “-” to adjust the volume of the other party’s voice.	—
8	Select to start talking with the other party.	165

INFORMATION

- Changing from hands-free call to cellular phone call is not possible while driving.
- When cellular phone call is changed to hands-free call, the hands-free screen will be displayed and its functions can be operated on the screen.
- Changing between cellular phone call and hands-free call can be performed by operating the cellular phone directly.
- Transferring methods and operations will be different depending on the type of cellular phone you have.
- For the operation of the cellular phone, see the manual that comes with it.

SENDING TONES

BY DIAL PAD

This operation cannot be performed while driving.

- 1 Select “0-9”.

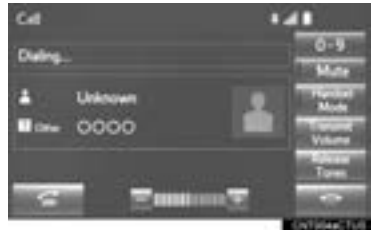

- 2 Enter the desired number.

BY SELECTING “Release Tones”

“Release Tones” appear when a continuous tone signal(s) containing a (w) is registered in the contact list.

This operation can be performed while driving.

- 1 Select “Release Tones”.

INFORMATION

- A continuous tone signal is a character string that consists of numbers and the characters p or w. (e.g. 056133w0123p#1*)
- When the “p” pause tone is used, the tone data up until the next pause tone will be automatically sent after 2 seconds have elapsed. When the “w” pause tone is used, the tone data up until the next pause tone will be automatically sent after a user operation is performed.
- Release tones can be used when automated operation of a phone based service such as an answering machine or bank phone service is desired. A phone number with continuous tone signals can be registered in the contact list.
- Tone data after a “w” pause tone can be operated on voice command during a call.

TRANSMIT VOLUME SETTING

- 1 Select “Transmit Volume”.
- 2 Select the desired level for the transmit volume.

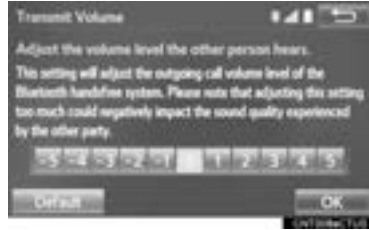



- 3 Select “OK”.

INFORMATION



- The sound quality of the voice heard from the other party’s speaker may be negatively impacted.
- To reset the transmit volume, select “Default”.
- “Transmit Volume” is dimmed when mute is on.

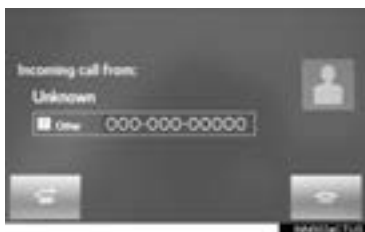

INCOMING CALL WAITING

When a call is interrupted by a third party while talking, this screen is displayed.

- 1 Select  or press the  switch on the steering wheel to start talking with the other party.



To refuse to receive the call: Select  or press the  switch on the steering wheel.

- Each time  is selected or the  switch on the steering wheel is pressed during an interrupted call, the party who is on hold will be switched.

INFORMATION

- This function may not be available depending on the type of cellular phone.

6. Bluetooth® PHONE MESSAGE FUNCTION

Received messages can be forwarded from the connected Bluetooth® phone, enabling checking and replying using the system.

Depending on the type of Bluetooth® phone connected, received messages may not be transferred to the message inbox.

If the phone does not support the message function, this function cannot be used.

1 Press the “APPS” button.

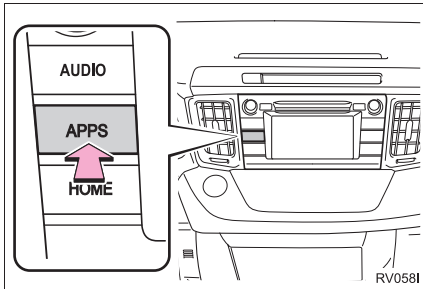



2 Select “Phone”.





• You can also display the message inbox screen to select “Messages”. (→STEP4)

3 Select .

• The phone top screen can be displayed by pressing the  switch on the steering wheel or  switch on the instrument panel.

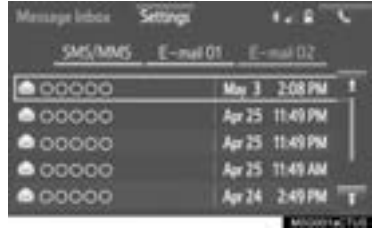
4 Check that the message inbox screen is displayed.



: Select to change to phone mode.

Function	Page
Receiving a message	167
Checking messages	167
Replying to a message (quick reply)	168
Calling the message sender	169
Message settings	181

RECEIVING A MESSAGE

When an e-mail/SMS/MMS is received, the incoming message screen pops up with sound and is ready to be operated on the screen.



No.	Function
1	Select to check the message.
2	Select to not open the message.
3	Select to call the message sender.

INFORMATION

- Depending on the cellular phone used for receiving messages, or its registration status with the system, some information may not be displayed.

- The pop up screen is separately available for incoming e-mail and SMS/MMS messages under the following conditions:

E-mail:

- “Incoming E-mail Display” is set to “Full Screen”. (→P.181)
- “E-mail Notification Popup” is set to on. (→P.181)

SMS/MMS:

- “Incoming SMS/MMS Display” is set to “Full Screen”. (→P.181)
- “SMS/MMS Notification Popup” is set to on. (→P.181)

CHECKING MESSAGES

- Display the message inbox screen. (→P.166)
- Select the desired message from the list.
- Check that the message is displayed.

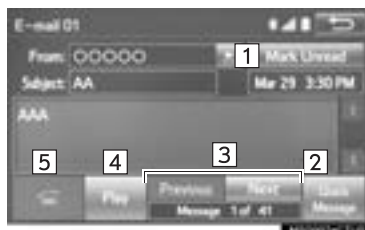

No.	Function
1*	Select “ Mark Unread ” or “ Mark Read ” to mark mail unread or read on the message inbox screen. This function is available when “Update Read Status on Phone” is set to on. (→P.181)
2	Select to reply the message. (→P.168)
3	Select to display the previous or next message.
4	Select to have messages read out. To cancel this function, select “ Stop ”. When “Automatic Message Read-out” is set to on, messages will be automatically read out. (→P.181)
5	Select to make a call to the sender.

*: E-mail only

INFORMATION

- Reading a text message is not available while driving.
- Depending on the type of Bluetooth® phone being connected, it may be necessary to perform additional steps on the phone.
- Messages are displayed in the appropriate connected Bluetooth® phone's registered mail address folder. Select the tab of the desired folder to be displayed.
- Only received messages on the connected Bluetooth® phone can be displayed.
- The text of the message is not displayed while driving.
- Turn the "PWR VOL" knob, or use the volume control switch on the steering wheel to adjust the message read out volume.

REPLYING TO A MESSAGE (QUICK REPLY)

15 messages have already been stored.

- 1 Display the message inbox screen. (→P.166)
- 2 Select the desired message from the list.
- 3 Select "Quick Message".



- 4 Select the desired message.
- 5 Select "Send".
 - While the message is being sent, a sending message screen is displayed.
 - To cancel sending the message, select "Cancel".

■ EDITING QUICK REPLY MESSAGES

This operation cannot be performed while driving.

- 1 Select **“Quick Message”**.



- 2 Select  corresponding to the desired message to edit.
- 3 Select **“OK”** when editing is completed.

INFORMATION

- To reset the editquick reply messages, select **“Default”**.

- **“Quick Message 1” (“I am driving and will arrive in approximately [ETA] minutes.”)*:**

This message cannot be edited and will automatically fill in [ETA] with the navigation calculated estimated time of arrival on the confirm message screen. If there are waypoints set, [ETA] to the next waypoint will be shown.

If there is no route currently set in the navigation system, “Quick Message 1” cannot be selected.

*: With navigation function

CALLING THE MESSAGE SENDER

Calls can be made to an e-mail/SMS/MMS message sender's phone number.

This operation can be performed while driving.

■ CALLING FROM E-MAIL/SMS/MMS MESSAGE DISPLAY

- 1 Display the message inbox screen. (→P.166)
- 2 Select the desired message.
- 3 Select .



- If there are 2 or more phone numbers, select the desired number.
- 4 Check that the “Call” screen is displayed.

■ CALLING FROM A NUMBER WITH- IN A MESSAGE

Calls can be made to a number identified in a message's text area.

This operation cannot be performed while driving.

- 1 Display the message inbox screen. (→P.166)
- 2 Select the desired message.
- 3 Select the text area.



- 4 Select the desired number.
 - Identified phone numbers contained in the message are displayed.
- 5 Check that the "Call" screen is displayed.

INFORMATION

- A series of numbers may be recognized as a phone number. Additionally, some phone numbers may not be recognized, such as those for other countries.

1. PHONE/MESSAGE SETTINGS

- 1 Press the “APPS” button.

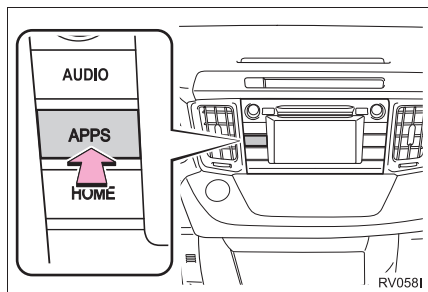

- 2 Select “Setup”.
- 3 Select “Phone”.
- 4 Select the item to be set.

PHONE/MESSAGE SETTINGS SCREEN

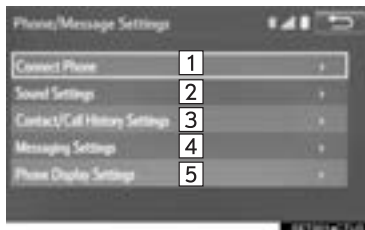

No.	Information	Page
1	Registering/connecting a phone	45
2	Sound settings	172
3	Contact/call history settings	173
4	Messaging settings	181
5	Phone display settings	182

DISPLAYING THE PHONE/MESSAGE SETTINGS SCREEN IN A DIFFERENT WAY

- 1 Display the phone top screen. (→P.156)
- 2 Select “Settings”.

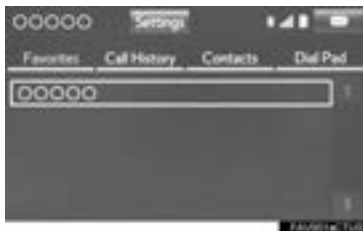

“Sound Settings” SCREEN

The call and ringtone volume can be adjusted. A ringtone can be selected.

- 1 Display the “Phone/Message Settings” screen. (→P.171)
- 2 Select “**Sound Settings**”.
- 3 Select the desired item to be set.

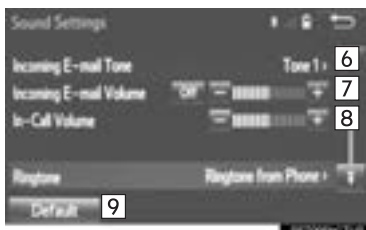
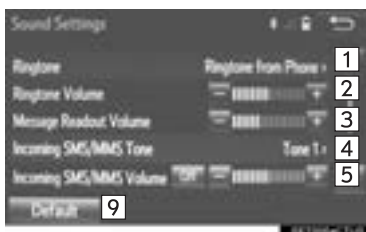

No.	Function
1	Select to set the desired ringtone.
2	Select “-” or “+” to adjust the ringtone volume.
3	Select “-” or “+” to adjust the message readout volume.
4	Select to set the desired incoming SMS/MMS tone.
5	Select “-” or “+” to adjust the incoming SMS/MMS tone volume.
6	Select to set the desired incoming e-mail tone.
7	Select “-” or “+” to adjust the incoming e-mail tone volume.
8	Select “-” or “+” to adjust the default volume of the other party’s voice.
9	Select to reset all setup items.

INFORMATION

- Depending on the type of phone, certain functions may not be available.

“Contact/Call History Settings” SCREEN

The contact can be transferred from a Bluetooth® phone to the system. The contact also can be added, edited and deleted.

The call history can be deleted and contact and favorites can be changed.

- 1 Display the “Phone/Message Settings” screen. (→P.171)
- 2 Select “**Contact/Call History Settings**”.
- 3 Select the desired item to be set.

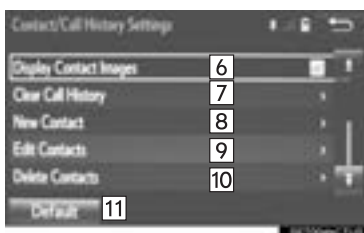
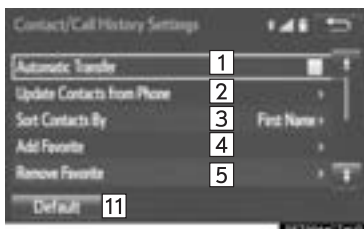

No.	Function	Page
1	For PBAP compatible Bluetooth® phones, select to set automatic contact/history transfer on/off. When set to on, the phone's contact data and history are automatically transferred.	—
2	Select to update contacts from the connected phone.	174
3	Select to sort contacts by the first name or last name field.	—
4	Select to add contacts to the favorites list.	178
5	Select to delete contacts from the favorites list.	180
6	Select to set the transferred contact image display on/off.	—
7*	Select to clear contacts from the call history.	—
8*	Select to add new contacts to the contact list.	175
9*	Select to edit contacts in the contact list.	176
10*	Select to delete contacts from the contact list.	177
11	Select to reset all setup items.	—

*: For PBAP compatible Bluetooth® phones, this function is available when “Automatic Transfer” is set to off. (→P.173)

INFORMATION

- Depending on the type of phone, certain functions may not be available.
- Contact data is managed independently for every registered phone. When one phone is connected, another phone's registered data cannot be read.

UPDATE CONTACTS FROM PHONE

Operation methods differ between PBAP compatible and PBAP incompatible but OPP compatible Bluetooth® phones.

If your cellular phone is neither PBAP nor OPP compatible, the contacts cannot be transferred.

FOR PBAP COMPATIBLE Bluetooth® PHONES

- 1 Select **“Update Contacts from Phone”**.
 - Contacts are transferred automatically.
- 2 Check that a confirmation screen is displayed when the operation is complete.
 - This operation may be unnecessary depending on the type of cellular phone.
 - Depending on the type of cellular phone, OBEX authentication may be required when transferring contact data. Enter “1234” into the Bluetooth® phone.
 - If another Bluetooth® device is connected when transferring contact data, depending on the phone, the connected Bluetooth® device may need to be disconnected.
 - Depending on the type of Bluetooth® phone being connected, it may be necessary to perform additional steps on the phone.

FOR PBAP INCOMPATIBLE BUT OPP COMPATIBLE Bluetooth® PHONES

This operation cannot be performed while driving.

- 1 Select **“Update Contacts from Phone”**.
- 2 Transfer the contact data to the system using a Bluetooth® phone.
 - This operation may be unnecessary depending on the type of cellular phone.
 - Depending on the type of cellular phone, OBEX authentication may be required when transferring contact data. Enter “1234” into the Bluetooth® phone.
 - To cancel this function, select **“Cancel”**.
- 3 Check that a confirmation screen is displayed when the operation is complete.

■ UPDATING THE CONTACTS IN A DIFFERENT WAY (FROM THE “Call History” SCREEN)

For only OPP compatible Bluetooth® phones, this function is available when “Automatic Transfer” is set to off. (→P.173)

- 1 Display the phone top screen. (→P.156)
- 2 Select the “**Call History**” tab and select a contact not yet registered in the contact list.
- 3 Select “**Update Contact**”.
- 4 Select the desired contact.
- 5 Select a phone type for the phone number.

REGISTERING A NEW CONTACT TO THE CONTACT LIST

New contact data can be registered.

Up to 4 numbers per person can be registered. For PBAP compatible Bluetooth® phones, this function is available when “Automatic Transfer” is set to off. (→P.173)

- 1 Select “**New Contact**”.
- 2 Enter the name and select “**OK**”.
- 3 Enter the phone number and select “**OK**”.
- 4 Select the phone type for the phone number.
- 5 To add another number to this contact, select “**Yes**”.

REGISTERING A NEW CONTACT IN A DIFFERENT WAY (FROM THE “Call History” SCREEN)

For only OPP compatible Bluetooth® phones, this function is available when “Automatic Transfer” is set to off. (→P.173)

- 1 Display the phone top screen. (→P.156)
- 2 Select the “**Call History**” tab and select a contact not yet registered in the contact list.
- 3 Select “**Add to Contacts**”.
- 4 Follow the steps in “REGISTERING A NEW CONTACT TO THE CONTACT LIST” from “STEP 2”. (→P.175)

EDITING THE CONTACT DATA

For PBAP compatible Bluetooth® phones, this function is available when “Automatic Transfer” is set to off. (→P.173)

- 1 Select “**Edit Contacts**”.
- 2 Select the desired contact.
- 3 Select  corresponding to the desired name or number.



- ▶ For editing the name
- 4 Follow the steps in “REGISTERING A NEW CONTACT TO THE CONTACT LIST” from “STEP 2”. (→P.175)
- ▶ For editing the number
- 4 Follow the steps in “REGISTERING A NEW CONTACT TO THE CONTACT LIST” from “STEP 3”. (→P.175)

■ EDITING THE CONTACT IN A DIFFERENT WAY (FROM THE “Contact Details” SCREEN)

- 1 Display the phone top screen. (→P.156)
- 2 Select the “**Contacts**”, “**Call History**” tab or the “**Favorites**” tab and select the desired contact.
- 3 Select “**Edit Contact**”.



“**E-mail Addresses**”: Select to display all registered e-mail addresses for the contact.

- 4 Follow the steps in “EDITING THE CONTACT DATA” from “STEP 4”. (→P.176)

DELETING THE CONTACT DATA

For PBAP compatible Bluetooth® phones, this function is available when “Automatic Transfer” is set to off. (→P.173)

- 1 Select “**Delete Contacts**”.
- 2 Select the desired contact and select “**Delete**”.
- 3 Select “**Yes**” when the confirmation screen appears.

INFORMATION

- Multiple data can be selected and deleted at the same time.

■ DELETING THE CONTACT IN A DIFFERENT WAY (FROM THE “Contact Details” SCREEN)

- 1 Display the phone top screen. (→P.156)
- 2 Select the “**Contacts**”, “**Call History**” tab or the “**Favorites**” tab and select the desired contact.
- 3 Select “**Delete Contact**”.
- 4 Select “**Yes**” when the confirmation screen appears.

INFORMATION

- When a Bluetooth® phone is deleted, the contact data will be deleted at the same time.

■ FAVORITES LIST SETTING

Up to 15 contacts (maximum of 4 numbers per contact) can be registered in the favorites list.

■ REGISTERING THE CONTACTS IN THE FAVORITES LIST

- 1 Select “**Add Favorite**”.
- 2 Select the desired contact to add to the favorites list.

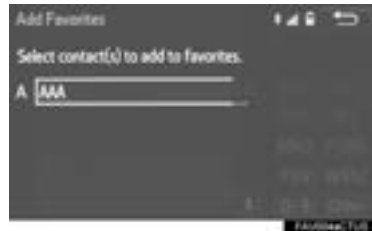

- Dimmed contacts are already stored as a favorite.
- 3 Check that a confirmation screen is displayed when the operation is complete.

► When 15 contacts have already been registered to the favorites list

- 1 When 15 contacts have already been registered to the favorites list, a registered contact needs to be replaced. Select **“Yes”** when the confirmation screen appears to replace a contact.
- 2 Select the contact to be replaced.

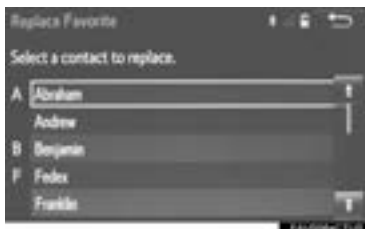

- 3 Check that a confirmation screen is displayed when the operation is complete.

► Registering contacts in the favorites list in a different way (from the “Contacts” screen)

- 1 Display the phone top screen. (→P.156)
- 2 Select the **“Contacts”** tab.
- 3 Select ☆ at the beginning of the desired contact list name to be registered in the favorites list.

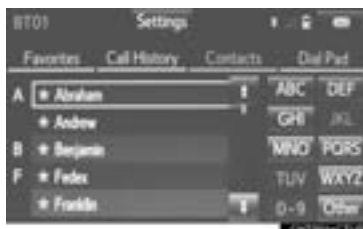

- When selected, ☆ is changed to ★, and the contact is registered in the favorites list.
- Registering contacts in the favorites list in a different way (from the “Contact Details” screen)
- 1 Display the phone top screen. (→P.156)
 - 2 Select the **“Contacts”** tab or the **“Call History”** tab and select the desired contact.
 - 3 Select **“Add Favorite”**.
 - 4 Check that a confirmation screen is displayed when the operation is complete.

■ DELETING THE CONTACTS IN THE FAVORITES LIST

- 1 Select **“Remove Favorite”**.
- 2 Select the desired contacts and select **“Remove”**.



- 3 Select **“Yes”** when the confirmation screen appears.
- 4 Check that a confirmation screen is displayed when the operation is complete.

▶ Deleting contacts in the favorites list in a different way (from the “Contacts” screen)

- 1 Display the phone top screen. (→P.156)
- 2 Select the **“Contacts”** tab.
- 3 Select ★ at the beginning of the contact list name to be deleted from the favorites list.

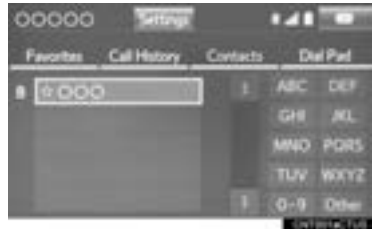

● When selected, ★ is changed to ☆, and the data is deleted from the list.

▶ Deleting contacts in the favorites list in a different way (from the “Contact Details” screen)

- 1 Display the phone top screen. (→P.156)
- 2 Select the **“Contacts”**, **“Call History”** tab or the **“Favorites”** tab and select the desired contact to delete.
- 3 Select **“Remove Favorite”**.
- 4 Select **“Yes”** when the confirmation screen appears.
- 5 Check that a confirmation screen is displayed when the operation is complete.

“Messaging Settings” SCREEN

- 1 Display the “Phone/Message Settings” screen. (→P.171)
- 2 Select “**Messaging Settings**”.
- 3 Select the desired item to be set.

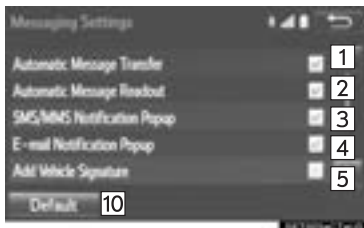

No.	Function
1	Select to set automatic message transfer on/off.
2	Select to set automatic message readout on/off.
3	Select to set the SMS/MMS notification popup on/off.
4	Select to set the e-mail notification popup on/off.
5	Select to set adding the vehicle signature to outgoing messages on/off.
6	Select to set updating message read status on phone on/off.
7	Select to change the incoming SMS/MMS display. “Full Screen” : When an SMS/MMS message is received, the incoming SMS/MMS display screen is displayed and can be operated on the screen. “Drop-down” : When an SMS/MMS message is received, a message is displayed on the upper side of the screen.
8	Select to change the incoming e-mail display. “Full Screen” : When an e-mail is received, the incoming e-mail display screen is the displayed and can be operated on the screen. “Drop-down” : When an e-mail is received, a message is displayed on the upper side of the screen.
9	Select to set display of messaging account names on the inbox tab on/off. When set to on, messaging account names used on the cellular phone will be displayed.
10	Select to reset all setup items.

INFORMATION

- Depending on the phone, these functions may not be available.

DISPLAYING THE “Messaging Settings” SCREEN IN A DIFFERENT WAY

- 1 Display the phone top screen. (→P.156)
- 2 Select .
- 3 Select “Settings”.

“Phone Display Settings” SCREEN

- 1 Display the “Phone/Message Settings” screen. (→P.171)
- 2 Select “**Phone Display Settings**”.
- 3 Select the desired item to be set.



No.	Function
1	Select to change the incoming call display. “Full Screen” : When a call is received, the hands-free screen is displayed and can be operated on the screen. “Drop-down” : A message is displayed on the upper side of the screen.
2	Select to set display of the contact/history transfer completion message on/off.
3	Select to reset all setup items.

INFORMATION

- Depending on the phone, these functions may not be available.

1. TROUBLESHOOTING

If there is a problem with the hands-free system or a Bluetooth® device, first check the table below.

► When using the hands-free system with a Bluetooth® device

Symptom	Likely cause	Solution	Page	
			Cellular phone	This system
The hands-free system or Bluetooth® device does not work.	The connected device may not be a compatible Bluetooth® cellular phone.	For a list of specific devices which operation has been confirmed on this system, check with your Toyota dealer or the following website: http://www.toyota.com/entune/	*	—
	The Bluetooth® version of the connected cellular phone may be older than the specified version.	Use a cellular phone with Bluetooth® version 2.0 or higher (recommended: Ver. 3.0 +EDR or higher).	*	44

► When registering/connecting a cellular phone

Symptom	Likely cause	Solution	Page	
			Cellular phone	This system
A cellular phone cannot be registered.	An incorrect pass-code was entered on the cellular phone.	Enter the correct pass-code on the cellular phone.	*	—
	The registration operation has not been completed on the cellular phone side.	Complete the registration operation on the cellular phone (approve registration on the phone).	*	—
	Old registration information remains on either this system or the cellular phone.	Delete the existing registration information from both this system and the cellular phone, then register the cellular phone you wish to connect to this system.	*	47
A Bluetooth® connection cannot be made.	Another Bluetooth® device is already connected.	Manually connect the cellular phone you wish to use to this system.	—	48
	Bluetooth® function is not enabled on the cellular phone.	Enable the Bluetooth® function on the cellular phone.	*	—
	Automatic Bluetooth® connection on this system is set to off.	<p>Set automatic Bluetooth® connection on this system to on when the engine switch is in following.</p> <p>► Vehicles without a smart key system The engine switch is turned to the “ACC” or “ON” position.</p> <p>► Vehicles with a smart key system The engine switch is turned to ACCESSORY or IGNITION ON mode.</p>	—	52

Symptom	Likely cause	Solution	Page	
			Cellular phone	This system
“Unable to dial. Please check your phone.”	Bluetooth® function is not enabled on the cellular phone.	Enable the Bluetooth® function on the cellular phone.	*	—
	Old registration information remains on either this system or the cellular phone.	Delete the existing registration information from both this system and the cellular phone, then register the cellular phone you wish to connect to this system.	*	47

► When making/receiving a call

Symptom	Likely cause	Solution	Page	
			Cellular phone	This system
A call cannot be made/received.	Your vehicle is in a “No Service” area.	Move to where “No Service” no longer appears on the display.	—	—

► When using the phonebook

Symptom	Likely cause	Solution	Page	
			Cellular phone	This system
Phonebook data cannot be transferred manually/automatically.	The profile version of the connected cellular phone may not be compatible with transferring phonebook data.	For a list of specific devices which operation has been confirmed on this system, check with your Toyota dealer or the following website: http://www.toyota.com/entune/	*	—
	Automatic contact transfer function on this system is set to off.	Set automatic contact transfer function on this system to on.	—	173
	Passcode has not been entered on the cellular phone.	Enter the passcode on the cellular phone if requested (default passcode: 1234).	*	—
	Transfer operation on the cellular phone has not completed.	Complete transfer operation on the cellular phone (approve transfer operation on the phone).	*	—
Phonebook data cannot be edited.	Automatic contact transfer function on this system is set to on.	Set automatic contact transfer function on this system to off.	—	173

► When using the Bluetooth® message function

Symptom	Likely cause	Solution	Page	
			Cellular phone	This system
Messages cannot be viewed.	Message transfer is not enabled on the cellular phone.	Enable message transfer on the cellular phone (approve message transfer on the phone).	*	—
	Automatic transfer function on this system is set to off.	Set automatic transfer function on this system to on.	—	181
New message notifications are not displayed.	Notification of SMS/MMS/E-mail reception on this system is set to off.	Set notification of SMS/MMS/E-mail reception on this system to on.	*	181
	Automatic message transfer function is not enabled on the cellular phone.	Enable automatic transfer function on the cellular phone.	*	—

► In other situations

Symptom	Likely cause	Solution	Page	
			Cellular phone	This system
<p>The Bluetooth® connection status is displayed at the top of the screen each time the engine switch is in following.</p> <p>► Vehicles without a smart key system The engine switch is turned to the “ACC” or “ON” position.</p> <p>► Vehicles with a smart key system The engine switch is turned to ACCESSORY or IGNITION ON mode.</p>	<p>Connection confirmation display on this system is set to on.</p>	<p>To turn off the display, set connection confirmation display on this system to off.</p>	—	51

Symptom	Likely cause	Solution	Page	
			Cellular phone	This system
Even though all conceivable measures have been taken, the symptom status does not change.	The cellular phone is not close enough to this system.	Bring the cellular phone closer to this system.	—	—
	The cellular phone is the most likely cause of the symptom.	Turn the cellular phone off, remove and reinstall the battery pack, and then restart the cellular phone.	*	—
		Enable the cellular phone's Bluetooth® connection.	*	—
		Stop the cellular phone's security software and close all applications.	*	—
		Before using an application installed on the cellular phone, carefully check its source and how its operation might affect this system.	*	—

*: For details, refer to the owner's manual that came with the cellular phone.

1 BASIC OPERATION

1. QUICK REFERENCE	192
MAP SCREEN	192
NAVIGATION OPTIONS SCREEN	194
2. MAP SCREEN OPERATION	195
CURRENT POSITION DISPLAY	195
MAP SCALE	195
ORIENTATION OF THE MAP	196
SWITCHING THE MAP MODE.....	197
SCREEN SCROLL OPERATION	199
ADJUSTING LOCATION IN SMALL INCREMENTS.....	200
3. MAP SCREEN INFORMATION	201
DISPLAYING MAP INFORMATION	201
DISPLAYING INFORMATION ABOUT THE ICON WHERE THE CURSOR IS SET	203
STANDARD MAP ICONS	204
4. TRAFFIC INFORMATION	205
DISPLAYING TRAFFIC INFORMATION ON THE MAP	207

2 DESTINATION SEARCH

1. DESTINATION SEARCH SCREEN	208
2. SEARCH OPERATION.....	210
SELECTING SEARCH AREA	211
SETTING HOME AS DESTINATION.....	211
SETTING PRESET DESTINATIONS AS DESTINATION.....	211
SEARCHING BY ADDRESS.....	212
SEARCHING BY POINT OF INTEREST	213
SEARCHING FROM PREVIOUS DESTINATIONS	216
SEARCHING BY ADDRESS BOOK	216
SEARCHING BY EMERGENCY	217
SEARCHING BY INTERSECTION AND FREEWAY	217
SEARCHING BY MAP	219
SEARCHING BY COORDINATES.....	219
3. STARTING ROUTE GUIDANCE.....	220
STARTING ROUTE GUIDANCE.....	220
PAUSING GUIDANCE	223

NAVIGATION SYSTEM*

3 ROUTE GUIDANCE

1. **ROUTE GUIDANCE SCREEN** 224
 - SCREEN FOR ROUTE GUIDANCE 224
 - ROUTE OVERVIEW 225
 - DURING FREEWAY DRIVING 226
 - WHEN APPROACHING INTERSECTION 227
 - TURN LIST SCREEN 228
 - TURN-BY-TURN ARROW SCREEN 228
2. **TYPICAL VOICE GUIDANCE PROMPTS** 229
3. **EDITING ROUTE** 230
 - ADDING DESTINATIONS 231
 - REORDERING DESTINATIONS 231
 - DELETING DESTINATIONS 231
 - SETTING ROUTE PREFERENCES 232
 - SELECTING ROUTE TYPE 232
 - DETOUR SETTING 233
 - STARTING FROM ADJACENT ROAD 234

4 MEMORY POINTS

1. **MEMORY POINTS SETTINGS** 235
 - SETTING UP HOME 236
 - SETTING UP PRESET DESTINATIONS 237

- SETTING UP ADDRESS BOOK 239
- SETTING UP AREAS TO AVOID 241
- DELETING PREVIOUS DESTINATIONS 243

5 SETUP

1. **DETAILED NAVIGATION SETTINGS** 244
 - SCREENS FOR NAVIGATION SETTINGS 244
2. **TRAFFIC SETTINGS** 248
 - SCREEN FOR TRAFFIC SETTINGS 248
 - AUTO AVOID TRAFFIC 249
 - MY TRAFFIC ROUTES 250

6 TIPS FOR THE NAVIGATION SYSTEM

1. **GPS (GLOBAL POSITIONING SYSTEM)** 254
 - LIMITATIONS OF THE NAVIGATION SYSTEM 254
2. **MAP DATABASE VERSION AND COVERED AREA** 256
 - MAP INFORMATION 256
 - ABOUT THE MAP DATA 257

*: With navigation function

1. QUICK REFERENCE

MAP SCREEN

To display this screen, press the “**APPS**” button, then select “**Navigation**” on the “Apps” screen.

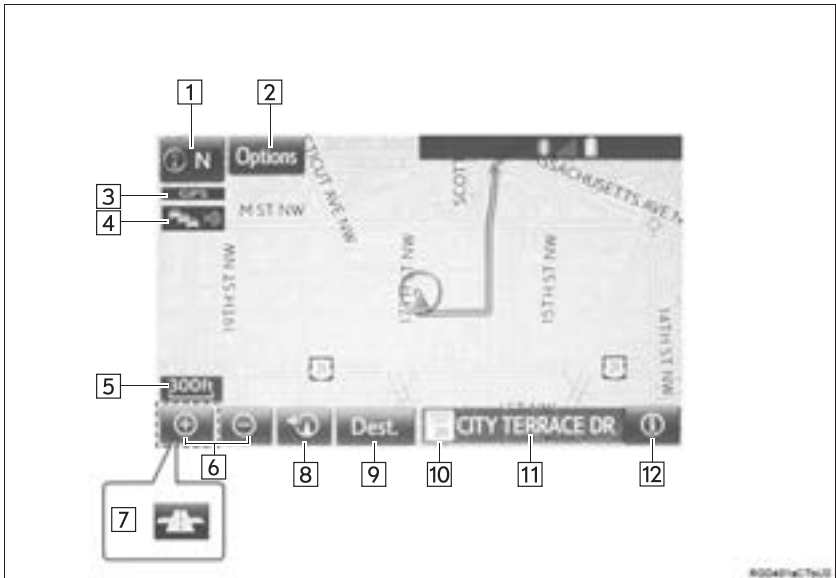

No.	Name	Function	Page
1	2D North-up, 2D heading-up or 3D heading-up symbol	Indicates whether the map orientation is set to north-up or heading-up. The letter(s) beside this symbol indicate the vehicle's heading direction (e.g. N for north). In 3D map, only a heading-up view is available.	196
2	Options button	Select to display the “Navigation Options” screen.	194
3	“GPS” mark (Global Positioning System)	Shows that the vehicle is receiving signals from the GPS.	254
4	Traffic indicator	Shows that traffic information is received. Select to start voice guidance for traffic information. When traffic information is received via HD, HD mark is displayed on the right.	205
5	Scale indicator	This figure indicates the map scale.	195

No.	Name	Function	Page
6	Zoom in/out button	Select to magnify or reduce the map scale. When either button is selected, the map scale indicator bar appears at the bottom of the screen.	195
7	Footprint map button	Select to display the footprint map screen.	196
8	Current position button/voice guidance button	<ul style="list-style-type: none"> • Select to display the current position address. • Select to repeat voice guidance. 	229
9	Destination button	Select to display the "Destination" screen.	208
10	Speed limit icon	Indicates the speed limit on the current road. The display of the speed limit icon can be set to on/off.	201
11	Route information bar	Displays the current street name, or the distance with the estimated travel time/arrival time to the destination. The route information bar fills from left to right as the vehicle progresses on the route.	224
12	Route information button	Select to change the display between the current street name and the distance with the estimated travel/arrival time.	224

NAVIGATION OPTIONS SCREEN

The navigation options allow you to change map configurations, display/hide POI icons, and edit the navigation routes. To display the “Navigation Options” screen, press the “**APPS**” button, select “**Navigation**” on the “Apps” screen, and select “**Options**” on the map screen.



No.	Function	Page
1	Select to display the desired map configuration.	197
2	Select to set display of the map information such as POI icons, route trace, speed limit, etc.	201
3	Select to display the map version and coverage area.	256
4	Select to edit the set route.	230
5	Select to pause or resume route guidance.	223
6	Select to display the overview of the entire route.	225

2. MAP SCREEN OPERATION

CURRENT POSITION DISPLAY

- 1 Press the “APPS” button.

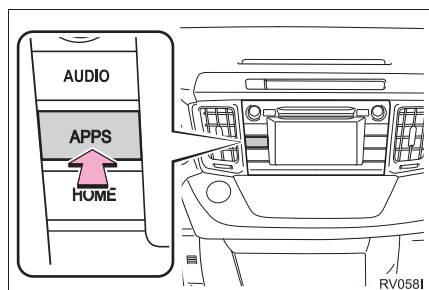

- 2 Select “Navigation”.
- 3 Check that the current position map is displayed.



- To correct the current position manually: →P.246

INFORMATION

- While driving, the current position mark is fixed on the screen and the map moves.
- The current position is automatically set as the vehicle receives signals from the GPS (Global Positioning System). If the current position is not correct, it is automatically corrected after the vehicle receives signals from the GPS.
- After the battery disconnection, or on a new vehicle, the current position may not be correct. As soon as the system receives signals from the GPS, the correct current position is displayed.

MAP SCALE

- 1 Select or to change the scale of the map screen.





- The scale indicator bar appears at the bottom of the screen.
- Select and hold or to continue changing the scale of the map screen.
- The scale of the map screen can also be changed by selecting the scale bar directly. This function is not available while driving.

INFORMATION

- The map scale is displayed above the zoom in button at the bottom left of the screen.
- In areas where the footprint map is available the map scale changes from to when at the minimum range.

FOOTPRINT MAP

For areas covered by the footprint map (some major cities), a footprint map on a scale of 75 ft. (25 m) can be selected. When the map is scaled down to 150 ft. (50 m),  changes to  and can be selected to display the footprint map.

- 1 Select  on the map screen.
- 2 Check that the footprint map is displayed.



- To return to the normal map display, select .

INFORMATION

- If the map or the current position is moved to the area which is not covered by the footprint map, the screen scale automatically changes to 150 ft. (50 m).
- On the footprint map, a one way street is displayed by .
- Scrolling on the footprint map is not available while driving.

Building footprints in the database were created and provided by NAVTEQ.

ORIENTATION OF THE MAP

The orientation of the map can be changed between 2D north-up, 2D heading-up and 3D heading-up by selecting the orientation symbol displayed at the top left of the screen.

- 1 Select ,  or .

► North-up screen



► Heading-up screen



▶ 3D screen



 : North-up symbol

Regardless of the direction of vehicle travel, north is always up.

 : Heading-up symbol

The direction of vehicle travel is always up.

 : 3D Heading-up symbol

The direction of vehicle travel is always up.

- The letter(s) beside this symbol indicate the vehicle's heading direction (e.g. N for north).

SWITCHING THE MAP MODE

- 1 Select “**Options**” on the map screen.
- 2 Select “**Map Mode**”.
- 3 Select the desired configuration button.

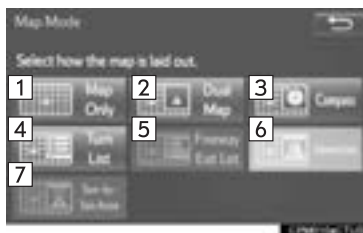

No.	Function	Page
1	Select to display the single map screen.	198
2	Select to display the dual map screen.	198
3	Select to display the compass mode screen.	199
4	Select to display the turn list screen.	228
5	Select to display the freeway exit list screen.	226
6	Select to display the intersection guidance screen or the guidance screen on the freeway.	227
7	Select to display the turn-by-turn arrow screen.	228

- Depending on the conditions, certain screen configuration buttons cannot be selected.

MAP ONLY



DUAL MAP



- The map on the left is the main map.

▶ Editing right map

The right side map can be edited.

- 1 Select any point on the right side map.
- 2 Select the desired item.



No.	Function	Page
1	Select to change the orientation of the map.	196
2	Select to display POI icons.	201
3	Select to show traffic information.	205
4	Select to change the map scale.	195

- When set to on, the indicator will illuminate.

COMPASS

Information about the destination, current position and a compass is displayed on the screen.





INFORMATION

- The destination mark is displayed in the direction of the destination. When driving, refer to the longitude and latitude coordinates, and the compass, to make sure that the vehicle is headed in the direction of the destination.
- When the vehicle travels out of the coverage area, the guidance screen changes to the whole compass mode screen.

SCREEN SCROLL OPERATION

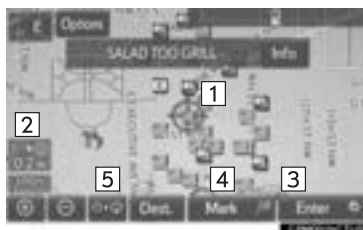
Use the scroll feature to move the desired point to the center of the screen for looking at a point on the map that is different from the current position.



No.	Information/Function
1	Cursor mark
2	Distance from the current position to the cursor mark.
3	Select to set as a destination. When selecting “Go to  <ul style="list-style-type: none"> ● To scroll over the map screen, place the cursor mark in the desired position and then touch and hold the map screen. The map will continue scrolling in that direction until the finger is released.

ADJUSTING LOCATION IN SMALL INCREMENTS

The cursor location can be adjusted in small increments when “**Adjust Location**” is selected on the setting map screen.

Also, when changing the location of memory points on the editing screen (P.241) and adjusting the current position mark manually on the “Calibration” screen (P.246), 8 directional arrows may appear for this purpose.

- 1 Select one of the 8 directional arrows to move the cursor to the desired point and then select “**OK**”.

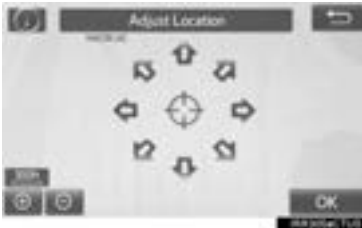

3. MAP SCREEN INFORMATION

DISPLAYING MAP INFORMATION

Information such as POI icons, route trace, speed limit, etc. can be displayed on the map screen.

- 1 Select “**Options**” on the map screen.
- 2 Select “**Map Information**”.
- 3 Select the desired items to be displayed.

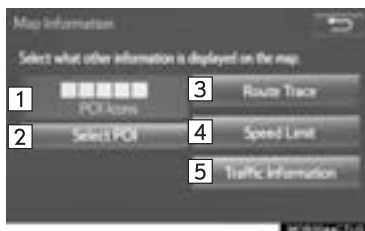

No.	Function	Page
1	Select to display the selected POI icons.	—
2	Select to select or change POI icons.	201
3	Select to display route trace.	203
4	Select to display speed limit icon.	—
5	Select to display traffic information.	205

- When set to on, the indicator will illuminate.

SELECTING THE POI ICONS

- 1 Display the “Map Information” screen. (→P.201)
 - 2 Select “**Select POI**”.
- When the POI icons to be displayed on the map screen have already been set, “**Change POI**” is displayed.
- 3 Select the desired POI category and select “**OK**”.

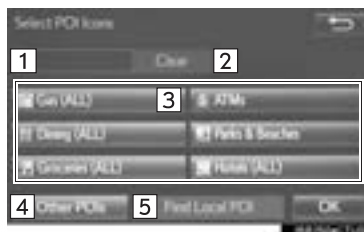

No.	Information/Function	Page
1	Displays up to 5 selected POI icons on the map screen	—
2	Select to cancel the selected POI icons.	—
3	Displays up to 6 POI icons as favorite POI categories	245
4	Select to display other POI categories if the desired POIs cannot be found on the screen.	202
5	Select to search for the nearest POIs.	202

■ SELECTING OTHER POI ICONS TO BE DISPLAYED

- 1 Select “**Other POIs**”.
- 2 Select the desired POI categories and select “**OK**”.



“**List All Categories**”: Select to display all POI categories. To add more POI categories, select “**More**”.

■ DISPLAYING THE LOCAL POI LIST

POIs that are within 20 miles (32 km) of the current position will be listed from among the selected categories.

- 1 Select “**Find Local POI**”.
- 2 Select the desired POI.



“**Near...**”: Select to search for POIs near the current position or along the route.

- 3 Check that the selected POI is displayed on the map screen. (→P.199)



►When “**Near...**” is selected

- 1 Select the desired item.
 “**Near Here**”: Select to search for POIs near the current position.
 “**Along My Route**”: Select to search for POIs along the route.

ROUTE TRACE

The traveled route can be stored and retraced on the map screen. This feature is available when the map scale is 30 miles (50 km) or less.

- 1 Display the "Map Information" screen. (→P.201)
- 2 Select "Route Trace".
 - The "Route Trace" indicator illuminates and the route trace starts.
- 3 Check that the traveled line is displayed.



STOP RECORDING THE ROUTE TRACE

- 1 Select "Route Trace" again.
- 2 A confirmation screen will be displayed.
 - "Yes": Select to keep the recorded route trace.
 - "No": Select to erase the recorded route trace.

INFORMATION

- The traveled route can be stored up to 124 miles (200 km).

DISPLAYING INFORMATION ABOUT THE ICON WHERE THE CURSOR IS SET

When the cursor is placed over an icon on the map screen, the name bar is displayed on the upper part of the screen. If "Info" appears on the right side of the name bar, detailed information can be displayed.

- 1 Place the cursor over an icon.
- 2 Select "Info".



▶ POI information

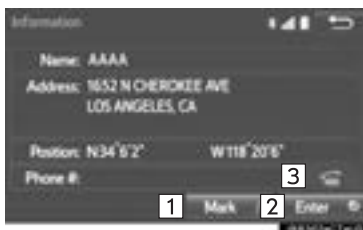

▶ Memory point information

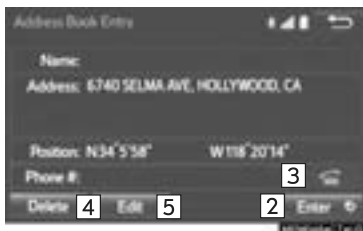

► Destination information

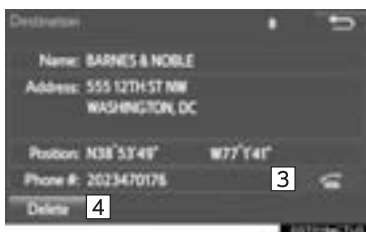











No.	Function
1	Select to register as a memory point. To change the icon, name, etc.: →P.239
2	Select to set as a destination.
3	Select to call the registered number.
4	Select to delete destination or memory point.
5	Select to display the edit memory point screen.

INFORMATION

- Even when traffic information is not currently being received, traffic information and “Info” will be displayed for a while after traffic information has been received.

STANDARD MAP ICONS

Icon	Name
	Island
	Park
	Industry
	Business facility
	Airport
	Military
	University
	Hospital
	Stadium
	Shopping mall
	Golf

4. TRAFFIC INFORMATION

Traffic data can be received via HD or Entune App Suite to display traffic information on the map screen.

- 1 Press the “**APPS**” button.

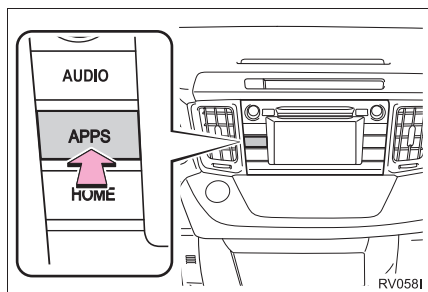

- 2 Select “**Traffic**”.
- 3 Select the desired item.



No.	Function	Page
1	Select to display a list of current traffic information.	205
2	Select to display a map with predictive traffic data.	206
3	Select to display traffic along the saved routes.	206

DISPLAYING TRAFFIC INFORMATION

A list of current traffic information can be displayed along with information on the incident's distance and position relative to the vehicle.

- 1 Display the “Traffic Information” screen. (→P.205)
- 2 Select “**Traffic Event List**”.
- 3 Select the desired traffic information.
 - “**On Current Road**”: Select to display traffic information for the current road.
 - “**On Current Route**”: Select to display traffic information for the set route.
- 4 Check that the traffic information is displayed.
 - When set to on, the indicator will illuminate.



- “**Detail**”: Select to display detailed traffic information.

DISPLAYING PREDICTIVE TRAFFIC INFORMATION

A map with predictive traffic data can be displayed.

- 1 Display the “Traffic Information” screen. (→P.205)
- 2 Select “**Predictive Traffic Map**”.
- 3 Scroll the map to the desired point and set the time of predictive traffic information.



- The time of the predictive traffic information can be displayed in 15-minute steps up to +45 minutes.
- “+”: Moves the time forward 15 minutes.
- “-”: Moves the time back 15 minutes.

MY TRAFFIC ROUTES

Traffic information along the saved routes can be displayed. To use this function, it is necessary to register a route. (→P.250)

- 1 Display the “Traffic Information” screen. (→P.205)
- 2 Select “**My Traffic Routes**”.
- If map data has been updated, a confirmation screen will be displayed. Select “**OK**” or “**Do Not Tell Me Again**”.
- 3 Select the desired route.



- “**Options**”: Select to add, edit or delete personal routes. (→P.250)
- If routes have not been registered yet, a confirmation screen will be displayed. Select “**Yes**” to register the route.
- 4 Select the desired traffic information.
 - 5 Check that the traffic information is displayed.





“**Detail**”: Select to display detailed traffic information.

DISPLAYING TRAFFIC INFORMATION ON THE MAP

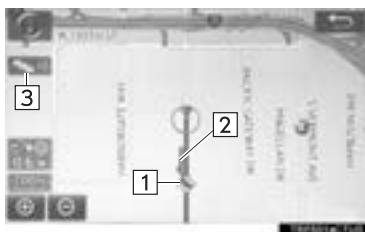
- 1 Select “**Options**” on the map screen.
 - 2 Select “**Map Information**”.
 - 3 Select “**Traffic Information**”.
- When set to on, the indicator will illuminate.
- 4 Check that the traffic information is displayed.



No.	Information/Function
1	The icons show traffic incident, road repair, traffic obstacles, etc. Select to display traffic information and start voice guidance for the traffic information.
2	The color of the arrow changes depending on the traffic information received.
3	The indicator is displayed as follows.  : Traffic information has been received.  : Traffic information has been received via HD. No icon: Any traffic information has not been received.

1. DESTINATION SEARCH SCREEN

The “Destination” screen enables to search for a destination. To display the “Destination” screen, press the “**APPS**” button, and select “**Navigation**” on the “Apps” screen. Then select “**Dest.**” on the map screen.

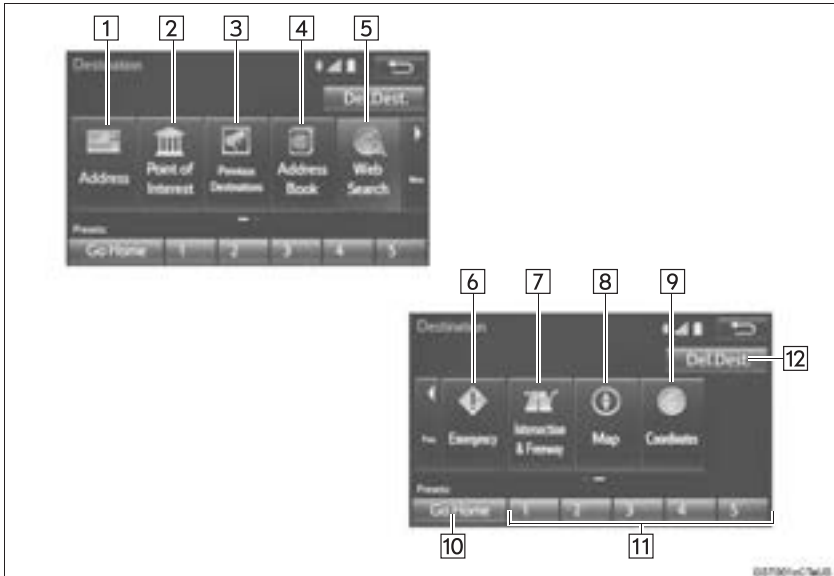

No.	Function	Page
1	Select to search for a destination by address.	212
2	Select to search for a destination by point of interest.	213
3	Select to search for a destination from previously set destinations.	216
4	Select to search for a destination from a registered entry in “Address book”.	216
5	Select to search for a destination by online database.	269
6	Select to search for a destination from emergency service points.	217
7	Select to search for a destination by intersection or freeway entrance/exit.	217
8	Select to search for a destination by the last displayed map.	219
9	Select to search for a destination by coordinates.	219
10	Select to set a destination by home.	211

No.	Function	Page
11	Select to set a destination from preset destinations.	211
12	Select to delete set destinations.	231

2. SEARCH OPERATION

1 Press the “APPS” button.

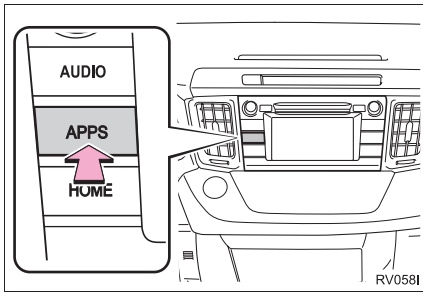

2 Select “Navigation”.

3 Select “Dest.”.

4 Search for a destination.



- There are different kinds of methods to search for a destination. (→P.208)

5 Select “Go” when the confirm destination screen is displayed.

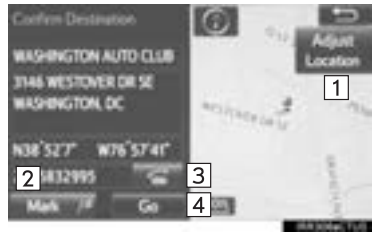

No.	Function
1	Select to adjust the position in smaller increments. (→P.200)
2	Select to register as a memory point.
3	Select to call the registered number.
4	Select to search for the route. (→P.220) If a destination has already been set, “Go Directly” and “Add to Route” will be displayed. “Go Directly”: Select to delete the existing destination(s) and set a new one. “Add to Route”: Select to add a destination.

SELECTING SEARCH AREA

The selected state (province) can be changed to set a destination from a different state (province) by using **“Address”**, **“Point of Interest”** or **“Intersection & Freeway”**.

- 1 Display the “Destination” screen. (→P.210)
- 2 Select **“Address”**, **“Point of Interest”** or **“Intersection & Freeway”**.
- 3 Select **“Select State/Province”** or **“Change State/Province”**.
 - If a state (province) has not been selected yet, **“Select State/Province”** is displayed.
- 4 Select the desired state (province).



- To change countries, select the **“United States”**, **“Canada”** or **“Mexico”** tab.
- For map database information and updates: →P.256

SETTING HOME AS DESTINATION

To use this function, it is necessary to register a home address. (→P.236)

- 1 Display the “Destination” screen. (→P.210)
- 2 Select **“Go Home”**.
 - The navigation system performs a search for the route and the entire route map is displayed. (→P.220)

SETTING PRESET DESTINATIONS AS DESTINATION

To use this function, it is necessary to register preset destinations to the preset screen buttons (1-5). (→P.237)

- 1 Display the “Destination” screen. (→P.210)
- 2 Select any of the preset destination buttons (1-5).



- The navigation system performs a search for the route and the entire route map is displayed. (→P.220)

SEARCHING BY ADDRESS

There are 2 methods to search for a destination by address.

- 1 Display the “Destination” screen. (→P.210)
- 2 Select “**Address**”.
- 3 Select the desired search method.

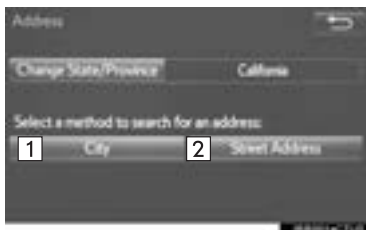

No.	Function	Page
1	Select to search by city.	212
2	Select to search by street address.	212

SEARCHING BY CITY

- 1 Select “**City**”.
 - 2 Enter a city name and select “**OK**”.
- “**Last 5 Cities**”: Select the city name from the list of the last 5 cities.
- 3 Select the desired city name.
 - 4 Enter a street name and select “**OK**”.
 - 5 Select the desired street name.
 - 6 Enter a house number and select “**OK**”.
- If the same address exists, the address list screen will be displayed. Select the desired address.

SEARCHING BY STREET ADDRESS

- 1 Select “**Street Address**”.
 - 2 Enter a house number and select “**OK**”.
 - 3 Enter a street name and select “**OK**”.
 - 4 Select the desired street name.
 - 5 Enter a city name and select “**OK**”.
 - 6 Select the desired city name.
- If the same address exists, the address list screen will be displayed. Select the desired address.

INFORMATION

- A street name can be searched using only the body part of its name. For example: S WESTERN AVE
 - A search can be performed by entering “S WESTERN AVE”, “WESTERN AVE” or “WESTERN”.

SEARCHING BY POINT OF INTEREST

There are 3 methods to search for a destination by Points of Interest.

- 1 Display the “Destination” screen. (→P.210)
- 2 Select “Point of Interest”.
- 3 Select the desired search method.

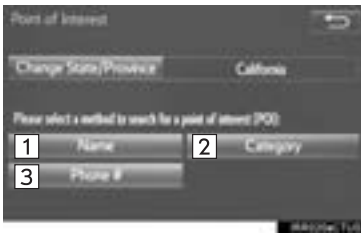

No.	Function	Page
1	Select to search by name.	213
2	Select to search by category.	214
3	Select to search by phone number.	215

SEARCHING BY NAME

- 1 Select “Name”.
- 2 Enter a POI name and select “OK”.
- 3 Select the desired POI.

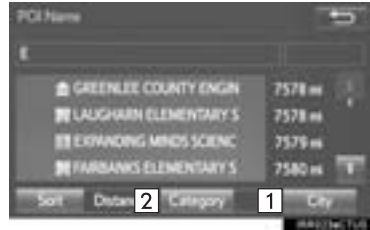

No.	Function	Page
1	Select to search for POI in the desired city.	214
2	Select to search for POI from the category list.	214

- When entering the name of a specific POI, and there are 2 or more sites with the same name, the list screen will be displayed. Select the desired POI.

INFORMATION

- To search for a facility name using multiple search words, put a space between each word.

■ SELECTING A CITY TO SEARCH

- 1 Select **“City”**.
- 2 Enter a city name and select **“OK”**.
“Any City”: Select to cancel the city setting.
- 3 Select the desired city name.
- 4 Select the desired POI.

■ SELECTING FROM THE CATEGORIES

- 1 Select **“Category”**.
- 2 Select the desired category.



- If there is more than 1 detailed item of the selected category, the detailed list will be displayed.

“List All Categories”: Select to display all POI categories.

- 3 Select the desired POI.

■ SEARCHING BY CATEGORY

- 1 Select **“Category”**.
- 2 Select the desired search point.

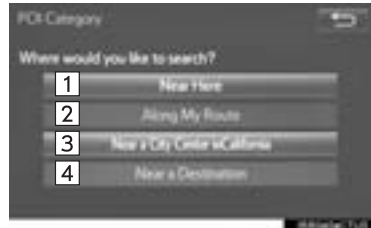

No.	Function
1	Select to set the search point from near the current position.
2	Select to search for POIs along the set route.
3	Select to set the search point from near a city center. (→P.215)
4	Select to set the search point from near a destination.

- 3 Select the desired POI category.



- If there is more than 1 detailed item of the selected category, the detailed list will be displayed.

“List All Categories”: Select to display all POI categories.

“Favorite POI Categories”: Select to use the 6 POIs that have been previously set. (→P.245)

- 4 Select the desired POI.

INFORMATION

- The names of POIs located within approximately 200 miles (320 km) from the selected search point can be displayed.
- ▶ When “Near a City Center in XX*” is selected
- 1 Select “**Near a City Center in XX**”.
 - 2 Enter a city name and select “**OK**”.
- “**Last 5 Cities**”: Select the city name from the list of the last 5 cities.
- 3 Select the desired city name.
 - 4 Select “**OK**” when the city center map screen is displayed.
 - 5 Follow the steps from 3 onward in “SEARCHING BY CATEGORY”. (→P.214)
- *:XX represents the selected search area name.

INFORMATION

- If the navigation system has never been used, selecting the city name from “**Last 5 Cities**” will not be available.

SEARCHING BY PHONE NUMBER

- 1 Select “**Phone #**”.
 - 2 Enter a phone number and select “**OK**”.
- If there is more than 1 site with the same number, the list screen will be displayed.

INFORMATION

- If there is no match for the entered phone number, a list of identical numbers with different area codes will be displayed.

SEARCHING FROM PREVIOUS DESTINATIONS

- 1 Display the “Destination” screen. (→P.210)
- 2 Select “**Previous Destinations**”.
- 3 Select the desired destination.

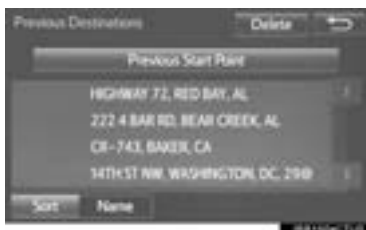

“**Previous Start Point**”: Select to display the start point map of the previous guided route.

“**Delete**”: Select to delete the previous destination. (→P.243)

INFORMATION

- The previous start point and up to 100 previously set destinations are displayed on the screen.

SEARCHING BY ADDRESS BOOK

To use this function, it is necessary to register an address book entry. (→P.239)

- 1 Display the “Destination” screen. (→P.210)
- 2 Select “**Address Book**”.
- 3 Select the desired address book entry.



- “**Options**”: Select to register or edit address book entries. (→P.239)

SEARCHING BY EMERGENCY

- 1 Display the “Destination” screen. (→P.210)
- 2 Select “**Emergency**”.
- 3 Select the desired emergency category.

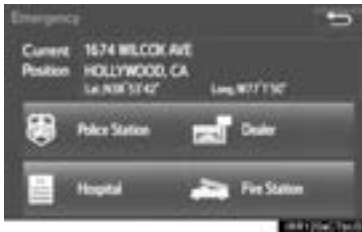

- 4 Select the desired destination.

INFORMATION

- The navigation system does not guide in areas where route guidance is unavailable. (→P.255)

SEARCHING BY INTERSECTION AND FREEWAY

There are 2 methods to search for a destination by Intersection & Freeway.

- 1 Display the “Destination” screen. (→P.210)
- 2 Select “**Intersection & Freeway**”.
- 3 Select the desired method.



No.	Function	Page
1	Select to search by intersection.	218
2	Select to search by freeway entrance/exit.	218

SEARCHING BY INTERSECTION

- 1 Select **“Intersection”**.
- 2 Enter the name of the first intersecting street which is located near the destination and select **“OK”**.
- 3 Select the desired street name.



- 4 Enter the name of the second intersecting street and select **“OK”**.
- 5 Select the desired street name.
- If the 2 streets cross at more than 1 intersection in a city, the list of intersections will be displayed.



SEARCHING BY FREEWAY ENTRANCE/EXIT

- 1 Select **“Freeway Entrance / Exit”**.
- 2 Enter a freeway name and select **“OK”**.
- 3 Select the desired freeway.
- 4 Select **“Entrance”** or **“Exit”**.

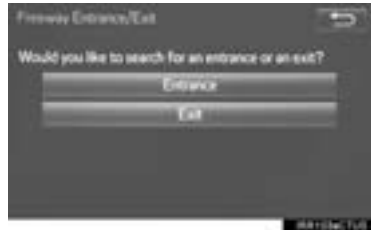

- 5 Enter a freeway entrance or exit name and select **“OK”**.
- 6 Select the desired entrance or exit name.

INFORMATION

- Be sure to use the complete name of the freeway or highway, including the hyphen, when entering the destination. Freeways and interstates use an “I” (I-405). US highways use the state designation before the number (CA-118).

SEARCHING BY MAP

By selecting **“Map”** the last displayed location is displayed again on the map screen. You can search for a destination from this map.

- 1 Display the “Destination” screen. (→P.210)
- 2 Select **“Map”**.
- 3 Scroll the map to the desired point and select **“Go to”**.



“Adjust Location”: Select to adjust the position in smaller increments. (→P.200)

● If a destination has already been set, **“Go to”** and **“Add to Route”** will be displayed.

“Go to”: Select to delete the existing destination(s) and set a new one.

“Add to Route”: Select to add a destination.

● The navigation system performs a search for the route and the entire route map is displayed. (→P.220)

SEARCHING BY COORDINATES

- 1 Display the “Destination” screen. (→P.210)
- 2 Select **“Coordinates”**.
- 3 Enter the latitude and longitude and select **“OK”**.



3. STARTING ROUTE GUIDANCE

When the destination is set, the entire route map from the current position to the destination is displayed.

STARTING ROUTE GUIDANCE

- 1 Select “OK” to start guidance.

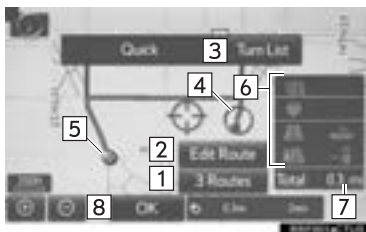

No.	Information/Function
1	Select the desired route from 3 possible routes. (→P.221)
2	Select to change the route. (→P.222)
3	Select to display a list of the turns required to reach the destination. (→P.222)
4	Current position
5	Destination point
6	Type of route and its distance
7	Distance of the entire route
8	Select to start guidance. If “OK” is selected and held until a beep sounds, demo mode will start. Press the “HOME” or “APPS” button to end demo mode.

CAUTION

- Be sure to obey traffic regulations and keep road conditions in mind while driving. If a traffic sign on the road has been changed, the route guidance may not indicate such changed information.

INFORMATION

- The route for returning may not be the same as that for going.
- The route guidance to the destination may not be the shortest route or a route without traffic congestion.
- Route guidance may not be available if there is no road data for the specified location.
- When setting the destination on a map with a scale more than 0.5 mile (800 m), the map scale changes to 0.5 miles (800 m) automatically. If this occurs, set the destination again.
- If a destination that is not located on a road is set, the vehicle will be guided to the point on a road nearest to the destination. The road nearest to the selected point is set as the destination.

3 ROUTES SELECTION

- 1 Select "3 Routes".
- 2 Select the desired route.

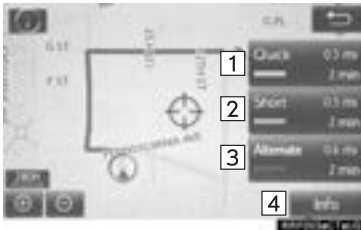

No.	Function
1	Select to display the quickest route.
2	Select to display the route that is the shortest distance to the set destination.
3	Select to display the alternative route.
4	Select to display the information about the 3 routes. (→P.221)

DISPLAYING 3 ROUTES INFORMATION

- 1 Select "Info".
- 2 Check that the "3 Route Information" screen is displayed.



No.	Information
1	Time necessary for the entire trip
2	Distance of the entire trip
3	Distance of the toll road
4	Distance of the freeway
5	Distance of the ferry trip

DISPLAYING TURN LIST

A list of turn information from the current position to the destination can be displayed.

- 1 Select “Turn List”.
- 2 Check that the turn list is displayed.

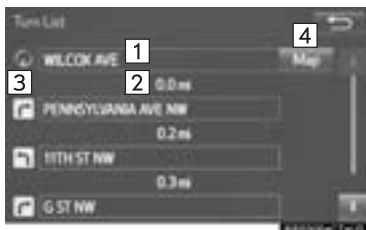

No.	Information
1	Current position
2	Distance to the next turn
3	Turn direction at the intersection
4	Select to display the map of the selected point.

INFORMATION

- However, not all road names on the route may appear on the list. If a road changes its name without requiring a turn (such as on a street that runs through 2 or more cities), the name change will not appear on the list. The street names will be displayed in order from the starting point, along with the distance to the next turn.

EDITING ROUTE

Destinations can be added, reordered or deleted, and conditions for the route to the destination can be changed.

- 1 Select “Edit Route”.
- 2 Select the desired item.



No.	Function	Page
1	Select to add destinations.	231
2	Select to delete destinations.	231
3	Select to reorder destinations.	231
4	Select to set route preferences.	232
5	Select to change route type.	232

INFORMATION

- Even if the “Freeways” indicator is dimmed, the route cannot avoid including a freeway in some cases. (→P.232)
- If the calculated route includes a trip by ferry, the route guidance shows a sea route. After traveling by ferry, the current position may be incorrect. Upon reception of GPS signals, it is automatically corrected.

PAUSING GUIDANCE

- 1 Select “**Options**” on the map screen.
- 2 Select “**Pause Guidance**”.

RESUMING GUIDANCE

- 1 Select “**Resume Guidance**”.

1. ROUTE GUIDANCE SCREEN

During the route guidance, various types of guidance screens can be displayed depending on conditions.

SCREEN FOR ROUTE GUIDANCE



No.	Information/Function
1	Distance to the next turn and an arrow indicating the turning direction
2	Guidance route
3	Current position
4	Current street name or route information

INFORMATION

- If the vehicle goes off the guidance route, the route is searched again.
- For some areas, the roads have not been completely digitized in our database. For this reason, the route guidance may select a road that should not be traveled on.
- When arriving at the set destination the destination name will be displayed on the upper part of the screen.

CHANGING ROUTE INFORMATION BAR

When the vehicle is on the guidance route, the route information bar displays the current street name or the distance with the estimated travel/arrival time to the destination.

- 1 Select the route information bar (1) or the route information button (2) to change the display of the route information bar.



No.	Information/Function
1	Select to change the display between the estimated travel time and the estimated arrival time.
2	Select to change the display between the current street name and the distance with the estimated travel/arrival time.

INFORMATION

- When the vehicle is on the guidance route, the distance measured along the route is displayed. Travel time and arrival time are calculated based on the average speed for the specified speed limit.
- When the vehicle gets off the guidance route, the arrow facing the destination is displayed instead of the estimated travel/arrival time.
- The route information bar fills from left to right as the vehicle progresses on the route.

DISTANCE AND TIME TO DESTINATION

When driving on the guidance route with more than 1 destination set, a list of the distance with estimated travel/arrival time from the current position to each destination is displayed.

- 1 Select the route information bar.
- 2 Check that the list of the distance and time is displayed.



- By selecting one of the number buttons, the desired route information is displayed.

ROUTE OVERVIEW

The entire route from the current position to the destination can be displayed during the route guidance.

- 1 Select “**Options**” on the map screen.
- 2 Select “**Route Overview**”.
- 3 Check that the entire route map is displayed.



- For details about this screen: →P.220

DURING FREEWAY DRIVING

During freeway driving, the freeway exit information screen will be displayed.

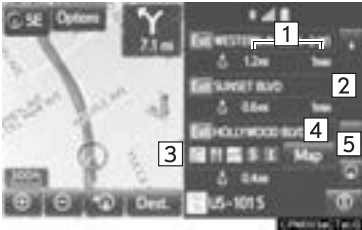

No./Icon	Information/Function
1	Distance and time from the current position to the road traffic facilities.
2	Name of the road traffic facilities.
3	POIs that are close to a freeway exit.
4	Select to display the selected map of the exit vicinity.
5	Select to display the nearest road traffic facilities from the current position.
	Select to scroll to farther road traffic facilities.
	Select to scroll to closer road traffic facilities.

WHEN APPROACHING FREEWAY EXIT OR JUNCTION

When the vehicle approaches an exit or junction, the freeway guidance screen will be displayed.

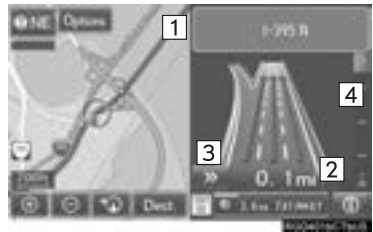

No.	Information/Function
1	Next exit or junction name
2	Distance from the current position to the exit or junction
3	Select to hide the freeway guidance screen. To return to the freeway guidance screen, select
4	Remaining distance bar to the guidance point

TOLLGATE GUIDANCE

When the vehicle approaches a tollgate, the tollgate view will be displayed.

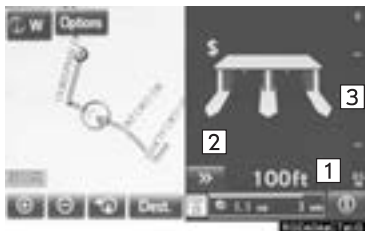

No.	Information/Function
1	Distance from the current position to the tollgate
2	Select to hide the tollgate guidance screen. To return to the tollgate guidance screen, select  .
3	Remaining distance bar to the guidance point

WHEN APPROACHING INTERSECTION

When the vehicle approaches an intersection, the intersection guidance screen will be displayed.

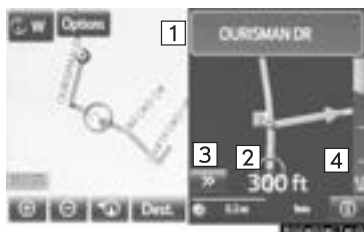

No.	Information/Function
1	Next street name
2	Distance to the intersection
3	Select to hide the intersection guidance screen. To return to the intersection guidance screen, select  .
4	Remaining distance bar to the guidance point

TURN LIST SCREEN

- 1 Select **“Turn List”** on the **“Map Mode”** screen. (→P.197)
- 2 Check that the turn list screen is displayed.



No.	Information/Function
1	Turn direction
2	Distance between turns
3	Next street or destination name

TURN-BY-TURN ARROW SCREEN

On this screen, information about the next turn on the guidance route can be displayed.

- 1 Select **“Turn-by-Turn Arrow”** on the **“Map Mode”** screen. (→P.197)
- 2 Check that the turn-by-turn arrow screen is displayed.



No.	Information/Function
1	Exit number or street name
2	Turn direction
3	Distance to the next turn

2. TYPICAL VOICE GUIDANCE PROMPTS

As the vehicle approaches an intersection, or point, where maneuvering the vehicle is necessary, the system's voice guidance will provide various messages.

 **CAUTION**

- Be sure to obey the traffic regulations and keep the road condition in mind especially when you are driving on IPD roads (roads that are not completely digitized in our database). The route guidance may not have the updated information such as the direction of a one way street.

INFORMATION

- If a voice guidance command cannot be heard, select  on the map screen to hear it again.
- To adjust the voice guidance volume:
→P.59
- Voice guidance may be made early or late.
- If the system cannot determine the current position correctly, you may not hear voice guidance or may not see the magnified intersection on the screen.

3. EDITING ROUTE

- 1 Press the “APPS” button.

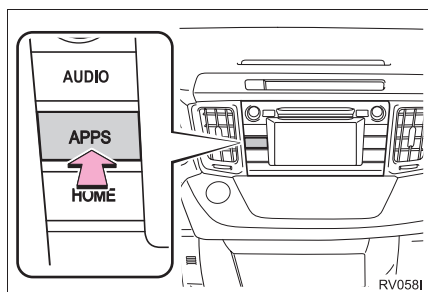

- 2 Select “Navigation”.
- 3 Select “Options”.
- 4 Select “Edit Route”.



- 5 Select the item to be set.



No.	Function	Page
1	Select to add destinations.	231
2	Select to delete destinations.	231
3	Select to reorder destinations.	231
4	Select to set route preferences.	232
5	Select to change route type.	232
6	Select to set detours.	233
7	Select to start from adjacent road.	234

- 6 Check that the entire route map is displayed. (→P.220)

ADDING DESTINATIONS

- 1 Display the “Edit Route” screen. (→P.230)
- 2 Select “Add”.
- 3 Search for an additional destination in the same way as a destination search. (→P.208)
- 4 Select “Add Destination Here” to insert the new destination into the route.



REORDERING DESTINATIONS

When more than 1 destination has been set, the arrival order of the destinations can be changed.

- 1 Display the “Edit Route” screen. (→P.230)
- 2 Select “Reorder”.
- 3 Select the desired destination and select “Move Up” or “Move Down” to change the arrival order. Then select “OK”.



DELETING DESTINATIONS

- 1 Display the “Edit Route” screen. (→P.230)
 - 2 Select “Delete”.
 - 3 Select “Yes” when the confirmation screen appears.
 - When more than 1 destination has been set, a list will be displayed on the screen. Select the item(s) to be deleted.
- “Delete All”: Select to delete all destinations on the list.
- If more than 1 destination has been set, the system will recalculate the route(s) to the set destination(s) as necessary.

SETTING ROUTE PREFERENCES

The conditions to determine the route can be selected from various choices such as freeways, toll roads, ferries, etc.

- 1 Display the “Edit Route” screen. (→P.230)
- 2 Select “**Preferences**”.
- 3 Select the desired route preferences and select “**OK**”.



- When set to on, the indicator will illuminate.

SELECTING ROUTE TYPE

- 1 Display the “Edit Route” screen. (→P.230)
- 2 Select “**Route Type**”.
- 3 Select the desired route type.



- During driving, the route guidance starts after selecting the desired route type.
- 4 The entire route from the starting point to the destination is displayed.
- For details about this screen: →P.220

DETOUR SETTING

During the route guidance, the route can be changed to detour around a section of the route where a delay is caused by road repairs, an accident, etc.

- 1 Display the “Edit Route” screen. (→P.230)
- 2 Select “**Detour**”.

- 3 Select the desired detour distance.

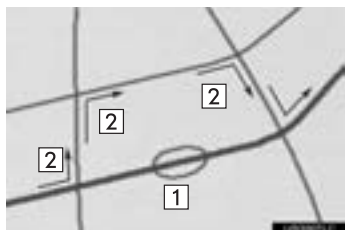

No.	Function
1	Select to detour within 1 mile of the current position.
2	Select to detour within 3 miles of the current position.
3	Select to detour within 5 miles of the current position.
4	Select to detour on the entire route.
5	Select to make the system search for the route based on traffic congestion information received from traffic information. (→P.205)

INFORMATION

- This picture shows an example of how the system would guide around a delay caused by a traffic jam.

1 This position indicates the location of a traffic jam caused by road repairs, an accident, etc.

2 This route indicates the detour suggested by the system.

- When the vehicle is on a freeway, the detour distance selections are 5, 15 and 25 miles (or 5, 15 and 25 km if units are in km).
- The system may not be able to calculate a detour route depending on the selected distance and surrounding road conditions.

STARTING FROM ADJACENT ROAD

When a freeway and a surface road run in parallel, the system may show the guidance route going on the freeway while driving on the surface road, or vice versa.

If this happens, you can instantly choose the adjacent road for the route guidance.

1 Display the “Edit Route” screen. (→P.230)

2 Select “**Start from Adjacent Road**”.

INFORMATION

- When there is no adjacent road, this screen button will not be displayed.

1. MEMORY POINTS SETTINGS

Home, preset destinations, address book entries, areas to avoid can be set as memory points. The registered points can be used as the destinations. (→P.208)

Registered areas to avoid, will be avoided when the system searches for a route.

- 1 Press the “APPS” button.

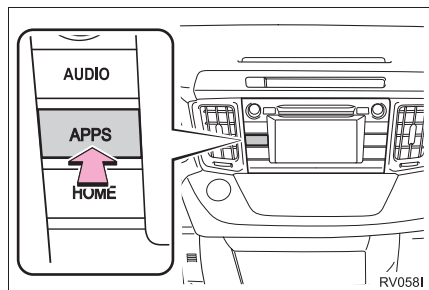

- 2 Select “Setup”.

- 3 Select “Navigation”.

- 4 Select the desired item to be set.



No.	Function	Page
1	Select to set home.	236
2	Select to set preset destinations.	237
3	Select to set the address book.	239
4	Select to set areas to avoid.	241
5	Select to delete previous destinations.	243
6	Select to set detailed navigation settings.	244

SETTING UP HOME

If home has been registered, that information can be recalled by selecting **“Go Home”** on the **“Destination”** screen. (→P.211)

- 1 Display the **“Navigation Settings”** screen. (→P.235)
- 2 Select **“Home”**.
- 3 Select the desired item to be set.



No.	Function	Page
1	Select to register home.	236
2	Select to edit home.	236
3	Select to delete home.	236

REGISTERING HOME

- 1 Select **“Set Home”**.
- 2 Select the desired item to search for the location. (→P.208)
- 3 Select **“OK”** when the editing home screen appears.

EDITING HOME

- 1 Select **“Edit”**.
- 2 Select the desired item to be edited.

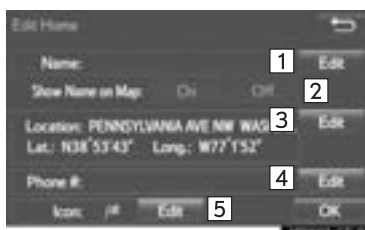

No.	Function	Page
1	Select to edit the home name.	241
2	Select to set display of the home name on/off.	—
3	Select to edit location information.	241
4	Select to edit the phone number.	241
5	Select to change the icon to be displayed on the map screen.	240

- 3 Select **“OK”**.

DELETING HOME

- 1 Select **“Delete”**.
- 2 Select **“Yes”** when the confirmation screen appears.

SETTING UP PRESET DESTINATIONS

If a preset destination has been registered, that information can be recalled by using preset destinations on the “Destination” screen. (→P.211)

- 1 Display the “Navigation Settings” screen. (→P.235)
- 2 Select “Preset Destinations”.
- 3 Select the desired item.



No.	Function	Page
1	Select to register a preset destination.	237
2	Select to edit a preset destination.	238
3	Select to delete a preset destination.	238

REGISTERING PRESET DESTINATIONS

- 1 Select “Set”.
- 2 Select the desired item to search for the location. (→P.208)
- 3 Select a position for this preset destination.



- 4 Select “OK” when the editing preset destination screen appears. (→P.238)

INFORMATION

- Up to 5 preset destinations can be registered.

EDITING PRESET DESTINATIONS

- 1 Select **“Edit”**.
- 2 Select the desired preset destination.
- 3 Select the item to be edited.

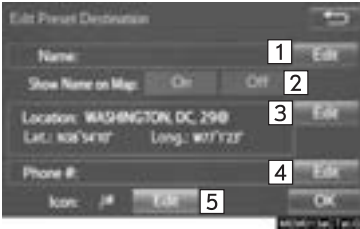

No.	Function	Page
1	Select to edit the preset destination name.	241
2	Select to set display of the preset destination name on/off.	—
3	Select to edit location information.	241
4	Select to edit the phone number.	241
5	Select to change the icon to be displayed on the map screen.	240

- 4 Select **“OK”**.

DELETING PRESET DESTINATIONS

- 1 Select **“Delete”**.
- 2 Select the preset destination to be deleted and select **“Delete”**.

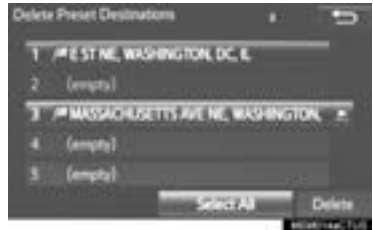

- 3 Select **“Yes”** when the confirmation screen appears.

SETTING UP ADDRESS BOOK

Points on the map can be registered.

- 1 Display the “Navigation Settings” screen. (→P.235)
- 2 Select “**Address Book**”.
- 3 Select the desired item.



No.	Function	Page
1	Select to register address book entries.	239
2	Select to edit address book entries.	239
3	Select to delete address book entries.	241

REGISTERING ADDRESS BOOK ENTRIES

- 1 Select “**New**”.
- 2 Select the desired item to search for the location. (→P.208)
- 3 Select “**OK**” when the editing address book entry screen appears. (→P.239)

INFORMATION

- Up to 100 address book entries can be registered.

EDITING ADDRESS BOOK ENTRIES

The icon, name, location and/or phone number of a registered address book entry can be edited.

- 1 Select “**Edit**”.
- 2 Select the desired address book entry.
- 3 Select the item to be edited.

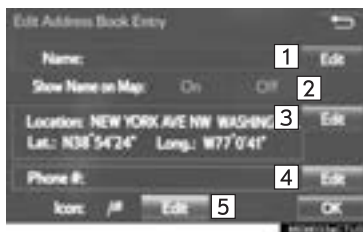

No.	Function	Page
1	Select to edit the address book entry name.	241
2	Select to set display of the address book entry name on/off.	—
3	Select to edit location information.	241
4	Select to edit the phone number.	241
5	Select to change the icon to be displayed on the map screen.	240

- 4 Select “**OK**”.

■ CHANGING THE ICON

- 1 Select **“Edit”** next to the **“Icon”**.
- 2 Select the desired icon.



- Change pages by selecting the **“Page 1”**, **“Page 2”** or **“With Sound”** tab.

“With Sound”: Select the memory points with a sound

► When the **“With Sound”** tab is selected

A sound for some address book entries can be set. When the vehicle approaches the location of the address book entry, the selected sound will be heard.

- 1 Select the **“With Sound”** tab.
- 2 Select the desired sound icon.



: Select to play the sound.

- When **“Bell (with Direction)”** is selected, select an arrow to adjust the direction and select **“OK”**.



INFORMATION

- The bell sounds only when the vehicle approaches this point in the direction that has been set.

■ CHANGING THE NAME

- 1 Select “**Edit**” next to “Name”.
- 2 Enter a name and select “**OK**”.

■ CHANGING THE LOCATION

- 1 Select “**Edit**” next to “Location”.
- 2 Scroll the map to the desired point (→P.200) and select “**OK**”.

■ CHANGING PHONE NUMBER

- 1 Select “**Edit**” next to “Phone #”.
- 2 Enter the phone number and select “**OK**”.

DELETING ADDRESS BOOK ENTRIES

- 1 Select “**Delete**”.
- 2 Select the item to be deleted and select “**Delete**”.



- 3 Select “**Yes**” when the confirmation screen appears.

SETTING UP AREAS TO AVOID

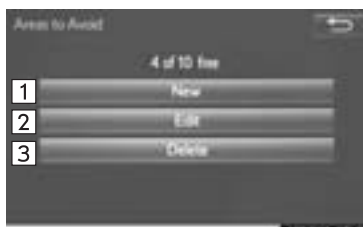

Areas to be avoided because of traffic jams, construction work or other reasons can be registered as “Areas to Avoid”.

- 1 Display the “Navigation Settings” screen. (→P.235)
- 2 Select “**Areas to Avoid**”.
- 3 Select the desired item.



No.	Function	Page
1	Select to register areas to avoid.	242
2	Select to edit areas to avoid.	242
3	Select to delete areas to avoid.	243

REGISTERING AREAS TO AVOID

- 1 Select **"New"**.
- 2 Select the desired item to search for the location. (→P.208)
- 3 Select either  or  to change the size of the area to be avoided and select **"OK"**.



- 4 Select **"OK"** when the editing area to avoid screen appears.

INFORMATION

- If a destination is entered in the area to avoid or the route calculation cannot be made without running through the area to avoid, a route passing through the area to be avoided may be shown.
- Up to 10 locations can be registered as points/areas to avoid.

EDITING AREAS TO AVOID

The name, location and/or area size of a registered area can be edited.

- 1 Select **"Edit"**.
- 2 Select the area and select **"OK"**.
- 3 Select the item to be edited.

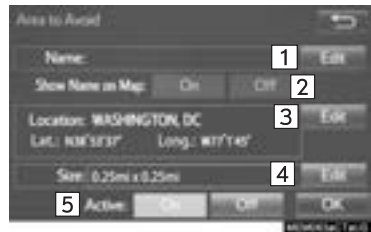

No.	Function	Page
1	Select to edit the name of the area to avoid.	243
2	Select to set display of the area to avoid name on/off.	—
3	Select to edit area location.	243
4	Select to edit area size.	243
5	Select to set the area to avoid function on/off.	—

- 4 Select **"OK"**.



■ CHANGING THE NAME

- 1 Select **“Edit”** next to **“Name”**.
- 2 Enter a name and select **“OK”**.

■ CHANGING THE LOCATION

- 1 Select **“Edit”** next to **“Location”**.
- 2 Scroll the map to the desired point (→P.200) and select **“OK”**.

■ CHANGING THE AREA SIZE

- 1 Select **“Edit”** next to **“Size”**.
- 2 Select either  or  to change the size of the area to be avoided and select **“OK”**.



DELETING AREAS TO AVOID

- 1 Select **“Delete”**.
- 2 Select the area to be deleted and select **“Delete”**.
- 3 Select **“Yes”** when the confirmation screen appears.

DELETING PREVIOUS DESTINATIONS

Previous destinations can be deleted.

- 1 Display the **“Navigation Settings”** screen. (→P.235)
- 2 Select **“Delete Previous Dest.”**.
- 3 Select the previous destination to be deleted and select **“Delete”**.



- 4 Select **“Yes”** when the confirmation screen appears.

5. SETUP

1. DETAILED NAVIGATION SETTINGS

Settings are available for pop-up information, favorite POI categories, low fuel warning, etc.

- 1 Press the **“APPS”** button.

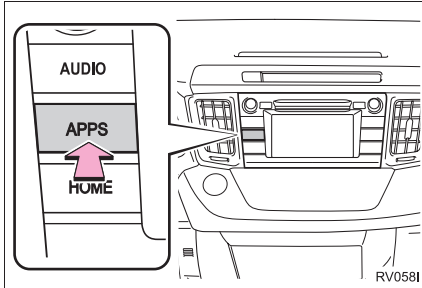

- 2 Select **“Setup”**.
- 3 Select **“Navigation”**.
- 4 Select **“Detailed Navi. Settings”**.
- 5 Select the items to be set.
- 6 Select **“OK”**.

SCREENS FOR NAVIGATION SETTINGS

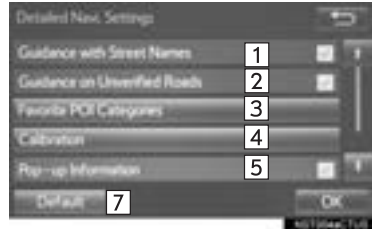

No.	Function	Page
1	Select to set the voice guidance for the next street name on/off.	—
2	Select to set IPD road guidance on/off.	—
3	Select to set favorite POI categories that are used for POI selection to display on the map screen.	245
4	Select to adjust the current position mark manually or to adjust miscalculation of the distance caused by tire replacement.	246
5	Select to set display of pop-up information on/off.	—
6	Select to set display of low fuel warning on/off.	247
7	Select to reset all setup items.	—

FAVORITE POI CATEGORIES (SELECT POI ICONS)

Up to 6 POI icons, which are used for selecting POIs on the map screen, can be selected as favorites.

- 1 Display the “Detailed Navi. Settings” screen. (→P.244)
- 2 Select “**Favorite POI Categories**”.
- 3 Select the category to be changed.



“**Default**”: Select to set the default categories.

- 4 Select the desired POI category.

“**List All Categories**”: Select to display all POI categories.

- 5 Select the desired POI icon.

CURRENT POSITION/TIRE CHANGE CALIBRATION

The current position mark can be adjusted manually. Miscalculation of the distance caused by tire replacement can also be adjusted.

- 1 Display the “Detailed Navi. Settings” screen. (→P.244)
- 2 Select “**Calibration**”.
- 3 Select the desired item.

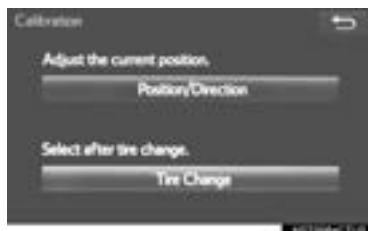

- For additional information on the accuracy of a current position: →P.254

POSITION/DIRECTION CALIBRATION

When driving, the current position mark will be automatically corrected by GPS signals. If GPS reception is poor due to location, the current position mark can be adjusted manually.

- 1 Select “**Position / Direction**”.
- 2 Scroll the map to the desired point (→P.200) and select “**OK**”.
- 3 Select an arrow to adjust the direction of the current position mark and select “**OK**”.



TIRE CHANGE CALIBRATION

The tire change calibration function will be used when replacing the tires. This function will adjust miscalculation caused by the circumference difference between the old and new tires.

- 1 Select “**Tire Change**”.
- The message appears and the quick distance calibration starts automatically.

INFORMATION

- If this procedure is not performed when the tires are replaced, the current position mark may be incorrectly displayed.

LOW FUEL WARNING POP-UP

When the fuel level is low, a warning message will pop up on the screen.

- 1 Display the “Detailed Navi. Settings” screen. (→P.244)
- 2 Select “Low Fuel Warning Pop-up”.

SEARCHING GAS STATION IN LOW FUEL WARNING

A nearby gas station can be selected as a destination.

- 1 Select “Yes” when the low fuel warning appears.
- 2 Select the desired nearby gas station.



- 3 Select “Enter ” to set as a destination.



“Info”: Select to display gas station information. (→P.203)

2. TRAFFIC SETTINGS

Traffic information such as traffic congestion or traffic incident warnings can be made available.

- 1 Press the “APPS” button.

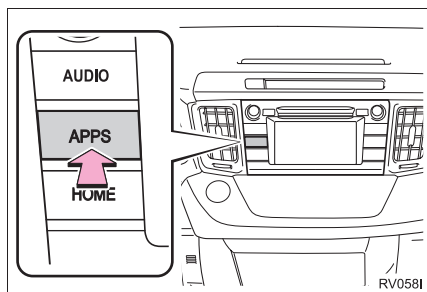

- 2 Select “Setup”.
- 3 Select “Traffic”.
- 4 Select the items to be set.
- 5 Select “OK”.

SCREEN FOR TRAFFIC SETTINGS



No.	Function
1	Select to set specific routes (such as frequently used routes) on which you wish to receive traffic information. (→P.250)
2	Select to set the avoid traffic function auto/manual. (→P.249)
3	Select to set the usage of traffic information for the estimated arrival time on/off.
4	Select to set the display of an arrow of free flowing traffic on/off.
5	Select to set to on/off whether to consider the predictive traffic information (→P.206) with estimated arrival time and detoured route search.
6	Select to set of traffic incident voice warning on/off.
7	Select to reset all setup items.

AUTO AVOID TRAFFIC

- 1 Display the “Traffic Settings” screen. (→P.248)
- 2 Select “**Avoid Traffic**”.
- 3 Select the desired item.

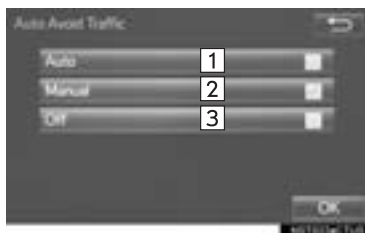

No.	Function
1	Select to automatically change routes when congestion information of the guidance route has been received.
2	Select to select manually whether or not to change routes when congestion information of the guidance route has been received. In this mode, a screen will appear to ask if you wish to reroute.
3	Select to not reroute when congestion information for the guidance route has been received.

- 4 Select “**OK**”.

CHANGING THE ROUTE MANUALLY

When the navigation system calculates a new route, the following screen will be displayed.

- 1 Select the desired item.

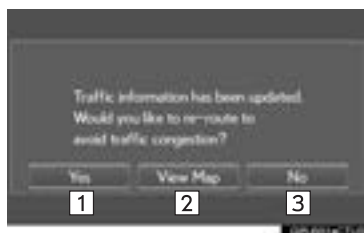

No.	Function
1	Select to start route guidance using the new route.
2	Select to confirm the new route and current route on the map.
3	Select to continue the current route guidance.

MY TRAFFIC ROUTES

Specific routes (such as frequently used routes) on which you wish to receive traffic information can be registered as “My Traffic Routes”. A route is set by defining a start point and end point, and can be adjusted by setting up to 2 preferred roads.

- 1 Display the “Traffic Settings” screen. (→P.248)
- 2 Select “My Traffic Routes”.
- 3 Select the desired item.



No.	Function	Page
1	Select to register personal routes.	250
2	Select to edit personal routes.	251
3	Select to delete personal routes.	251

REGISTERING PERSONAL ROUTES

- 1 Select “New”.
- 2 Select “Edit” next to “Name”.



- 3 Enter the name and select “OK”.
- 4 Select “Edit” next to “Start”.
- 5 Select the desired item to search for the location. (→P.208)

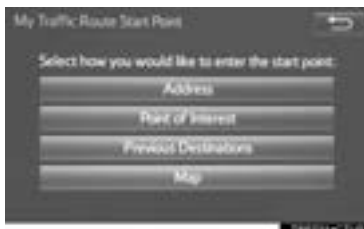

- 6 Select “Edit” next to “End”.
 - 7 Select the desired item to search for the location. (→P.208)
 - 8 Select “OK” when the editing traffic route screen appears.
- The routes can be adjusted by setting preferred roads. (→P.252)

INFORMATION

- Up to 5 routes can be registered.

EDITING PERSONAL ROUTES

- 1 Select **"Edit"**.
- 2 Select the desired traffic route.

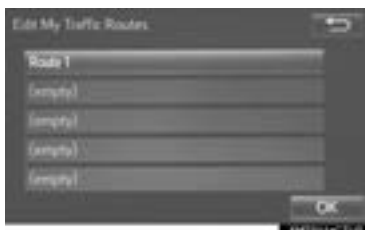

- 3 Select **"Edit"** next to the item to be edited.



No.	Function	Page
1	Select to edit the name of the personal route.	250
2	Select to edit start location.	
3	Select to edit end location.	
4	Select to see and modify the entire route.	252

- 4 Select **"OK"**.
 - The entire route map will be displayed.

DELETING PERSONAL ROUTES

- 1 Select **"Delete"**.
- 2 Select the traffic route to be deleted and select **"Delete"**.



- 3 Select **"Yes"** when the confirmation screen appears.

SETTING PREFERRED ROADS

“My Traffic Routes” can be adjusted by setting up to 2 preferred roads.

- 1 Select “Set Preferred Roads”.



- 2 Select the desired item.

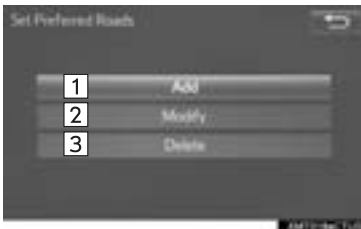

No.	Function	Page
1	Select to add preferred roads.	252
2	Select to modify preferred roads.	253
3	Select to delete preferred roads.	253

ADDING PREFERRED ROADS

- 1 Select “Add”.
- If two preferred roads are already set, select “Yes” and delete a preferred road before add a new one.
- 2 Scroll the map to the desired point and select “OK”.



- 3 Select “OK” to use this road.
“Next”: Select to change road.

- 4 Select “Add Here” for the desired location.



- If a preferred road is already set, a second preferred road can be added anywhere between the start point, the end point and the existing preferred road.

■ MODIFYING PREFERRED ROADS

- 1 Select **“Modify”**.
- 2 Select the preferred road to be modified if 2 preferred roads have been set.



- 3 Scroll the map to the desired point and select **“OK”**.



- 4 Select **“OK”** to use this road.
“Next”: Select to change road.

■ DELETING PREFERRED ROADS

- 1 Select **“Delete”**.
- 2 Select the preferred road to be deleted if 2 preferred roads have been set.



“Delete All”: Select to delete all preferred roads on the list.

- 3 Select **“Yes”** when the confirmation screen appears.

1. GPS (GLOBAL POSITIONING SYSTEM)

LIMITATIONS OF THE NAVIGATION SYSTEM

This navigation system calculates the current position using satellite signals, various vehicle signals, map data, etc. However, an accurate position may not be shown depending on satellite conditions, road configuration, vehicle condition or other circumstances.

The Global Positioning System (GPS) developed and operated by the U.S. Department of Defense provides an accurate current position, normally using 4 or more satellites, and in some case 3 satellites. The GPS system has a certain level of inaccuracy. While the navigation system compensates for this most of the time, occasional positioning errors of up to 300 ft. (100 m) can and should be expected. Generally, position errors will be corrected within a few seconds.



When the vehicle is receiving signals from satellites, the “GPS” mark appears at the top left of the screen.

The GPS signal may be physically obstructed, leading to inaccurate vehicle position on the map screen. Tunnels, tall buildings, trucks, or even the placement of objects on the instrument panel may obstruct the GPS signals.

The GPS satellites may not send signals due to repairs or improvements being made to them.

Even when the navigation system is receiving clear GPS signals, the vehicle position may not be shown accurately or inappropriate route guidance may occur in some cases.

 **NOTICE**

- The installation of window tinting may obstruct the GPS signals. Most window tinting contains some metallic content that will interfere with GPS signal reception of the antenna in the instrument panel. We advise against the use of window tinting on vehicles equipped with navigation systems.

- Accurate current position may not be shown in the following cases:
 - When driving on a small angled Y-shaped road.
 - When driving on a winding road.
 - When driving on a slippery road such as in sand, gravel, snow, etc.
 - When driving on a long straight road.
 - When freeway and surface streets run in parallel.
 - After moving by ferry or vehicle carrier.
 - When a long route is searched during high speed driving.
 - When driving without setting the current position calibration correctly.
 - After repeating a change of direction by going forward and backward, or turning on a turntable in a parking lot.
 - When leaving a covered parking lot or parking garage.
 - When a roof carrier is installed.
 - When driving with tire chains installed.
 - When the tires are worn.
 - After replacing a tire or tires.
 - When using tires that are smaller or larger than the factory specifications.
 - When the tire pressure in any of the 4 tires is not correct.
- If the vehicle cannot receive GPS signals, the current position can be adjusted manually. For information on setting the current position calibration: →P.246
- Inappropriate route guidance may occur in the following cases:
 - When turning at an intersection off the designated route guidance.
 - If you set more than 1 destination but skip any of them, auto reroute will display a route returning to the destination on the previous route.
 - When turning at an intersection for which there is no route guidance.
 - When passing through an intersection for which there is no route guidance.
 - During auto reroute, the route guidance may not be available for the next turn to the right or left.
 - During high speed driving, it may take a long time for auto reroute to operate. In auto reroute, a detour route may be shown.
 - After auto reroute, the route may not be changed.
 - If an unnecessary U-turn is shown or announced.
 - If a location has multiple names and the system announces 1 or more of them.
 - When a route cannot be searched.
 - If the route to your destination includes gravel, unpaved roads or alleys, the route guidance may not be shown.
 - Your destination point might be shown on the opposite side of the street.
 - When a portion of the route has regulations prohibiting the entry of the vehicle that vary by time or season or other reasons.
 - The road and map data stored in the navigation system may not be complete or may not be the latest version.

- After replacing a tire: →P.246

INFORMATION

- This navigation system uses tire turning data and is designed to work with factory-specified tires for the vehicle. Installing tires that are larger or smaller than the originally equipped diameter may cause inaccurate display of the current position. The tire pressure also affects the diameter of the tires, so make sure that the tire pressure of all 4 tires is correct.

2. MAP DATABASE VERSION AND COVERED AREA

MAP INFORMATION

Coverage areas and legal information can be displayed and map data can be updated.

- 1 Press the “APPS” button.

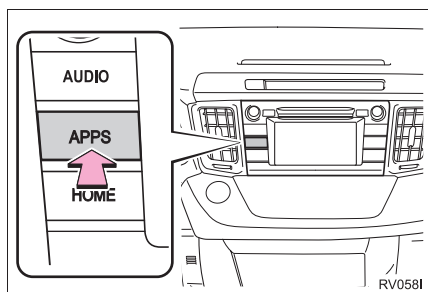

- 2 Select “Navigation”.
- 3 Select “Options”.
- 4 Select “Map Data”.

- 5 Check that the map data screen is displayed.



No.	Function
1	Map version
2	Select to display map coverage areas.
3	Select to display legal information.

INFORMATION

- Map data updates are available for a fee. Contact your Toyota dealer for further information.

ABOUT THE MAP DATA

Map data for the navigation system is contained in a SD card that is inserted in the SD card slot.

Do not eject the SD card, as doing so may deactivate the navigation system.

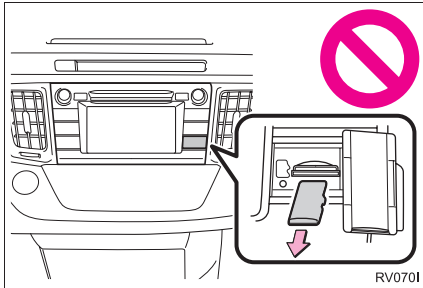

NOTICE

- Do not edit or delete the map data on the SD card, as doing so may deactivate the navigation system.

INFORMATION



- microSDHC Logo is a trademark of SD-3C,LLC.

Entune App Suite*

1 Entune App Suite OVERVIEW

- | | |
|---|------------|
| 1. Entune App Suite SERVICE | 260 |
| BEFORE USING THE FUNCTION | 262 |
| PREPARATION BEFORE USING Entune App Suite | 263 |

2 Entune App Suite OPERATION

- | | |
|--|------------|
| 1. Entune App Suite | 265 |
| USING Entune App Suite..... | 265 |
| LINKING Entune App Suite AND NAVIGATION FUNCTION | 269 |
| Entune App Suite KEYWORD OPERATION | 270 |

3 SETUP

- | | |
|--|------------|
| 1. Entune App Suite SETTINGS | 272 |
| SCREEN FOR Entune App Suite SETTINGS | 272 |

*: With navigation function

1. Entune App Suite SERVICE*

Entune App Suite is a service that enables downloadable applications to be displayed on and operated from the screen. Before Entune App Suite can be used, a few actions need to be performed first. (→P.263)

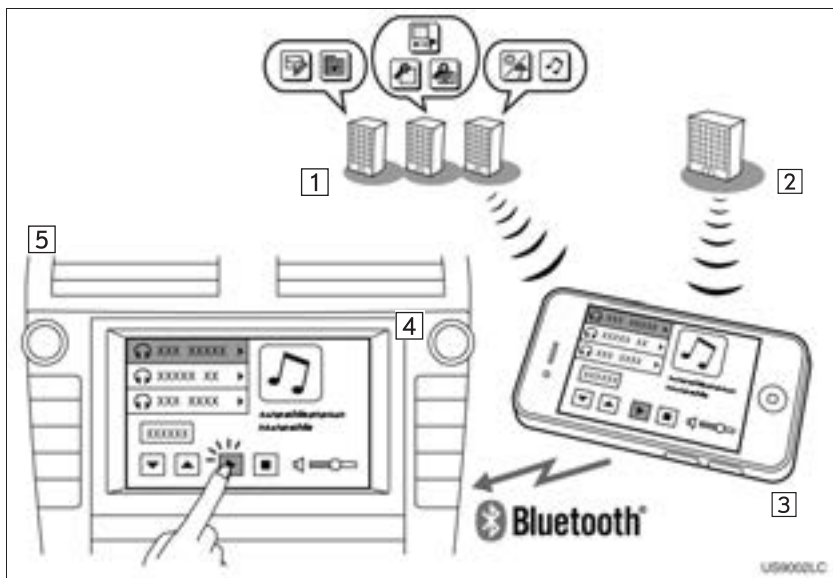

*: Entune App Suite is available in the contiguous United States, D.C. and Alaska.

No.	Name	Function
1	Content provider	Provides content to the system via a cellular phone.
2	Application server	Provides downloadable application to the system via a cellular phone.
3	Cellular phone*	Using the Entune App Suite application, communication is relayed between the system, the application server and the contents provider.
4	Applications	Downloaded Entune App Suite applications provide access to audio/visual content from a content provider when connected via a compatible phone with a data connection.
5	Entune App Suite	Contents received, via a cellular phone, from the contents provider servers are displayed on the screen. The system is equipped with an application player to run applications.

*: For known compatible phones, refer to <http://www.toyota.com/entune/>.

INFORMATION

- The actual service availability is dependent on the network condition.

BEFORE USING THE FUNCTION

SUBSCRIPTION

- User registration is required to start using the Entune App Suite service.
- Entune App suite does not require an activation fee or monthly recurring fees.
- Services requiring a separate contract can also be used.*

*: For details, refer to

<http://www.toyota.com/entune/> or call 1-800-331-4331.

AVAILABILITY OF SERVICE

- Entune App Suite is available in the contiguous United States, D.C. and Alaska.

INFORMATION

- When using Entune App Suite, depending on the details of your cellular phone contract, data usage fees may apply. Confirm data usage fees before using this service.
- In this section, the required actions to activate applications, connect a cellular phone to the system and registration steps for Entune App Suite are explained. For details regarding Entune App Suite operations and each of the applications, refer to <http://www.toyota.com/entune/>.
- The actual service availability is dependent on the network condition.

INITIALIZING PERSONAL DATA

The personal data used in applications can be removed from the system. (→P.58)

- The following personal data can be deleted from the system and returned to their default settings:
 - Downloaded applications
 - Downloaded application content

INFORMATION

- Once initialized, data will be erased from the system. Pay close attention when initializing the data.

PREPARATION BEFORE USING Entune App Suite

SETUP REQUIRED TO USE Entune App Suite

Perform the following actions.

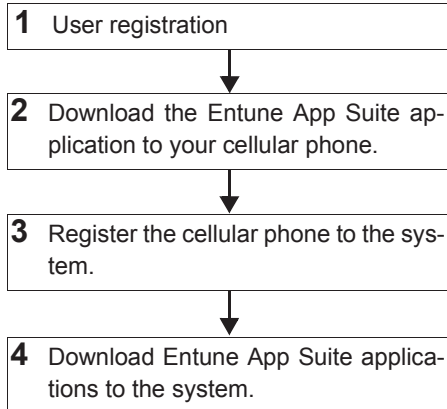

In order to use Entune App Suite, the following actions must first be performed:

- User registration with a service contract (→P.263)
- Download the Entune App Suite application onto your cellular phone, and login to the application. (→P.264)
- Register the cellular phone that the Entune App Suite application was downloaded to with the system. (→P.264)
- Register a Bluetooth® phone with the hands-free system. (→P.42)
- Download Entune App Suite applications to the system. (→P.266)

USER REGISTRATION

- 1 Perform user registration at <http://www.toyota.com/entune/>.

REGISTERING THE Entune App Suite APPLICATION

- 1 Download the Entune App Suite application to your cellular phone.
- 2 Run the Entune App Suite application on your cellular phone.
- 3 Enter the information required into the Entune App Suite application. Login to the application.

INFORMATION

- Applications can only be used when the Entune App Suite application has been downloaded to your cellular phone and the application is running.
- Entune App Suite operational procedures can also be confirmed by visiting <http://www.toyota.com/entune/>.
- In order to use applications, it is necessary to run the Entune App Suite application on your cellular phone.
- If an iPhone is connected via Bluetooth® and USB at the same time, system operation may become unstable. For known phone compatibility information, refer to <http://www.toyota.com/entune/>.
- If an Entune App Suite application is used while iPod audio is being played back, system operation may become unstable.

DOWNLOADING Entune App Suite APPLICATIONS

- 1 The actions on P.263 need to be performed before Entune App Suite applications can be downloaded.
- 2 Once your phone is running the Entune App Suite application with a valid account logged in and is connected to the system, an on-screen pop-up will be displayed offering to begin downloading Entune App Suite applications to the system. After download has started, see P.267 for more information.

1. Entune App Suite

USING Entune App Suite

Entune App Suite is a service that enables the usable contents of a cellular phone to be displayed on and operated from the screen. Before Entune App Suite can be used, a few actions need to be performed first. (→P.263)

For details about the function and service of each application, refer to <http://www.toyota.com/entune/>.

- 1** Press the “**APPS**” button.

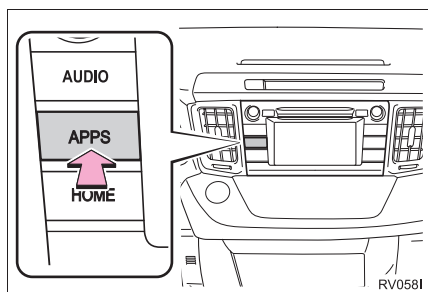

- 2** Select the desired application button.



No.	Function	Page
1	Select to activate an application.	—
2	Select to update the application.	266
3	Select to reorder the applications.	267

UPDATING an application

When Entune App Suite is activated, an application may need to be updated. By updating, an application can be kept to the latest version. When updating the application, it is necessary to download the updated data and install it.

DOWNLOADING THE UPDATED DATA

If an update is available, “**Update**” can be selected.

1 Select “**Update**”.



2 Check that downloading is started.



“**Download in Background**”: Select to operate other function while downloading.

“**Cancel**”: Select to cancel updating.

3 Check that downloading is completed.

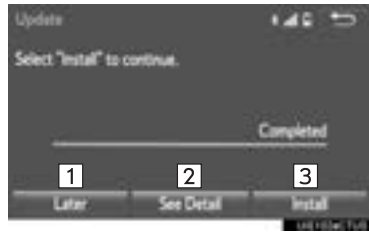

No.	Function
1	Select to install the update later. The screen will return to the last displayed screen. Installing the updated data later: →P.267
2	Select to display detailed information about the updated data.
3	Select to install the updated data. Follow the steps “INSTALLING THE UPDATED DATA” from “STEP 2”. (→P.267)

INFORMATION

- Application download time may vary based on the speed of the cellular network.
- Application download can be resumed after turning off and back on.
- Future mandatory updates will display an on-screen pop-up when available.
- Entune App Suite function cannot be operated while mandatory updates downloading.

■ INSTALLING THE UPDATED DATA

After the downloading is complete, **“Update”** will be changed to **“Install”**.

- 1 Select **“Install”**.
- 2 Select **“Continue”**.

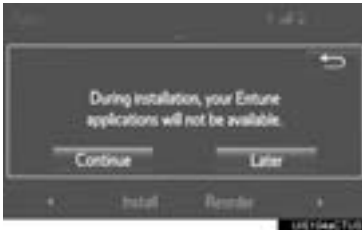

“Later”: Select to postpone the installation of the updated data and go back to the previous screen.

- 3 Check that installing is started.

“Install in Background”: Select to operate other function while installing.

- 4 Select **“OK”** after the installing is complete.

INFORMATION

- Entune App Suite function cannot be operated while installing.

REORDERING THE APPLICATIONS

Order of the applications can be changed.

- 1 Display the **“Apps”** screen. (→P.265)
- 2 Select **“Reorder”**.



- 3 Select the desired application to be moved.
- 4 Select **⏪** or **⏩** to move the application, and select **“OK”**.

IF A MESSAGE APPEARS ON THE SCREEN

When problems occur starting up the application player, a message will appear on the screen. Referring to the table below to identify the problem, take the suggested corrective action.

Message	Display conditions	Corrective action
"This feature is unavailable during an emergency call."	Safety Connect is being implemented.	After Safety Connect is finished, perform the operation again.
"This feature is unavailable while transferring contacts."	Contacts are being transferred manually from the phonebook.	When the transfer of contacts is complete, perform the operation.
"Unable to connect to a Bluetooth* phone. For troubleshooting assistance, please visit toyota.com ."	The cellular phone cannot be connected.	Refer to http://www.toyota.com/entune/ to confirm if the phone is compatible or not.
"This feature is unavailable during a handsfree call."	A hands-free call is in progress.	After the hands-free call is finished, perform the operation.
"To use these services, an active application needs to be running on your phone. For more information, please visit toyota.com ."	The Entune App Suite application cannot be connected to Bluetooth® SPP.	Refer to http://www.toyota.com/entune/ to confirm if the phone is Bluetooth® SPP compatible or not, and then activate the Entune App Suite application.
"Entune App Suite connection has been lost. Please confirm your connection."	Communication was disconnected.	After a few moments, retry the operation.

*: Bluetooth is a registered trademark of Bluetooth SIG, Inc.

LINKING Entune App Suite AND NAVIGATION FUNCTION

The system can set a destination and make a hands-free call via Entune App Suite. For details about the function and service of each application, refer to <http://www.toyota.com/entune/>.

- 1 Press the **"APPS"** button.

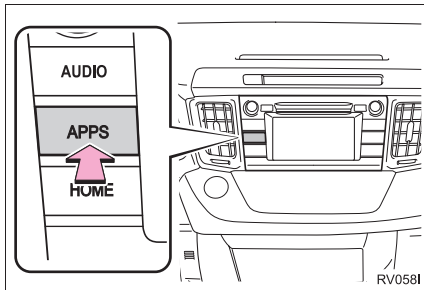

- 2 Select **"Navigation"**.
- 3 Select **"Dest."**.
- 4 Select **"Web Search"**.
- 5 Check that the **"Web Search"** screen is displayed.

SETTING A DESTINATION USING Entune App Suite

Locations that were searched using Entune App Suite can be set as a destination.

- 1 Display the **"Web Search"** screen. (→P.269)
- 2 Select the desired application button to search.
- 3 Enter a search term, and select **"GO"**.
- 4 Select **"Map"**.
- 5 Select **"Go to [location]"**.



- 6 Select **"OK"** to start guidance.

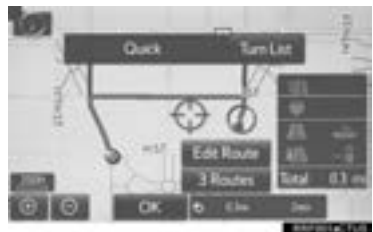

- For the operation of the route guidance screen and the function of each screen button: →P.220

**MAKING A PHONE CALL
USING Entune App Suite**

Phone calls can be made to locations which were searched using Entune App Suite.

- 1 Display the “Web Search” screen. (→P.269)
 - 2 Select the desired application button to search.
 - 3 Enter a search term, and select “GO”.
 - 4 Select “Call”.
 - 5 Select “Yes”.
- “Cancel”: Select to cancel making a phone call.
- 6 Check that the “Call” screen is displayed.

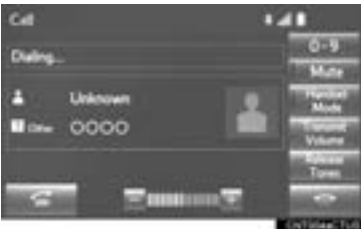

- For phone operation and the function of each screen button: →P.163

**Entune App Suite KEYWORD
OPERATION**

Information can be entered to an application by the software keyboard or voice recognition. For details about the function and service of each application, refer to <http://www.toyota.com/entune/>.

- The keyboard layout can be changed. (→P.53)

**USING THE SOFTWARE
KEYBOARD**

- 1 Display the “Apps” screen. (→P.265)
- 2 Select the desired application button.

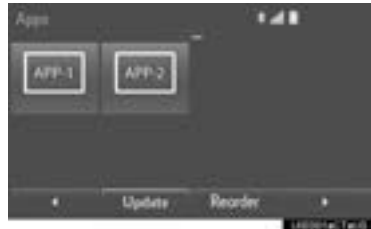

- 3 Select the character input space.
- 4 Enter a search term, and then select “OK”.

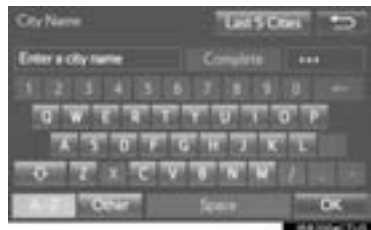

- 5 Entering characters will be reflected on the character input space.

- For details on operating the keyboard: →P.37

ENTERING A KEYWORD USING THE VOICE RECOGNITION FUNCTION

- 1 Display the “Apps” screen. (→P.265)
- 2 Select the desired application button.



- 3 Press the talk switch. (→P.124)
- 4 When this screen is displayed, say the desired keyword.
 - Completion of saying the keyword will be detected automatically.
- 5 Search results will be displayed on the screen.

3. SETUP

1. Entune App Suite SETTINGS

Settings are available for Entune App Suite.

- 1 Press the “APPS” button.

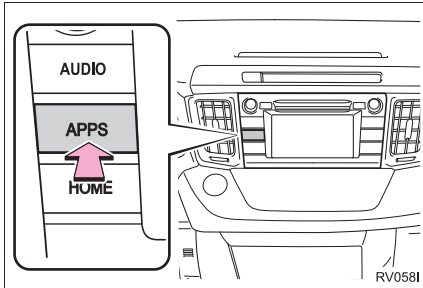

- 2 Select “Setup”.
- 3 Select “Entune”.
- 4 Select the items to be set.
- 5 Select “OK”.

SCREEN FOR Entune App Suite SETTINGS



No.	Function
1	Select to set the voice guidance volume.
2	Select to set the pop up reminder for cellular phone data usage. (→P.273)
3	Select to reset all setup items.

PHONE DATA PLAN POP-UP SETTINGS

The phone data plan pop-up can be set when a paid application is downloaded.

- 1 Display the “Entune Settings” screen. (→P.272)
- 2 Select “**Phone Data Plan Pop-Up**”.
- 3 Check the desired function to be operated.



- 4 Select “**OK**”.



INDEX

1

2

3

4

5

6

7

8

9

ALPHABETICAL INDEX

A

AM/FM radio	73
Available HD radio™ technology.....	80
Caching a radio program.....	77
Overview	73
Presetting a station.....	76
Radio broadcast data system.....	78
Selecting a station from the list	76
Traffic announcement (FM radio).....	79
Troubleshooting guide.....	82
Using HD radio™ technology.....	79
“Apps” screen.....	14
Audio remote controls	108
Audio settings	111
Audio settings screen	111
Audio system	65
AUX.....	106
Overview	106

B

Basic function.....	12, 31
Basic information before operation	32
Basic operation	66, 192
Bluetooth® audio.....	101
Connecting a Bluetooth® device	105
Listening to Bluetooth® audio.....	105
Overview	101
Bluetooth® phone message function	166
Calling the message sender.....	169
Checking messages.....	167
Receiving a message.....	167
Replying to a message (Quick reply)	168
Bluetooth® settings	42

C

Calling on the Bluetooth® phone.....	156
By call history	157
By contacts list.....	158
By dial pad.....	160
By favorites list	157
By “Home” screen.....	161
By off hook switch.....	160
Casual speech recognition	130
CD.....	90
Overview.....	90
Playing an audio CD.....	92
Playing an MP3/WMA/AAC disc.....	92
Command list	131

D

Data services settings.....	137
Setting download methods	137
Destination search	208
Destination search screen.....	208
Detailed navigation settings	244
Screens for navigation settings	244
Driver settings	60
Manually select linked settings.....	60

E	
Editing route.....	230
Adding destinations.....	231
Deleting destinations.....	231
Detour setting.....	233
Reordering destinations.....	231
Selecting route type.....	232
Setting route preferences.....	232
Starting from adjacent road.....	234
Entering letters and numbers/list screen operation.....	37
Entering letters and numbers.....	37
List screen.....	37
Entune App Suite.....	259, 265
Entune App Suite keyword operation.....	270
Linking Entune App Suite and navigation function.....	269
Using Entune App Suite.....	265
Entune App Suite operation.....	265
Entune App Suite overview.....	260
Entune App Suite service.....	260
Before using the function.....	262
Preparation before using Entune App Suite.....	263
Entune App Suite settings.....	272
Screen for Entune App Suite settings.....	272

F	
Function index.....	28

G	
General settings.....	53
General settings screen.....	53
GPS (Global positioning system).....	254
Limitations of the navigation system.....	254

H	
Home screen.....	16
Status display.....	18
Home screen operation.....	36

I	
Information.....	133
Initial screen.....	32
Internet radio.....	89
Listening to internet radio.....	89
iPod.....	97
iPod audio.....	100
iPod video.....	100
Overview.....	97

ALPHABETICAL INDEX

M

Maintenance	61
Map database version and covered area	256
About the map data	257
Map information.....	256
Map screen information	201
Displaying information about the icon where the cursor is set	203
Displaying map information	201
Standard map icons	204
Map screen operation	195
Adjusting location in small increments	200
Current position display.....	195
Map scale	195
Orientation of the map.....	196
Screen scroll operation.....	199
Switching the map mode	197
Media operation	90
Memory points	235
Memory points settings	235
Deleting previous destinations	243
Setting up address book.....	239
Setting up areas to avoid.....	241
Setting up home	236
Setting up preset destinations	237

N

Navigation operation	22
Navigation system.....	191

O

Operating information.....	113
CD player and disc	114
Error messages	121
File information	117
iPod	116
Radio	113
Terms	120
Operation flow: Guiding the route	26
Other settings.....	53
Overview buttons	12

P	
Peripheral monitoring system	139
Phone	151
Phone operation (Hands-free system for cellular phones).....	152
Phone/message settings	171
“Contact/Call History Settings” screen.....	173
“Messaging Settings” screen.....	181
“Phone Display Settings” screen.....	182
Phone/message settings screen.....	171
“Sound Settings” screen.....	172

Q	
Quick guide	11
Quick reference	20, 66, 152, 192
Map screen	192
Navigation options screen.....	194

R	
Radio operation.....	73
Rear view monitor system.....	140
Driving precautions.....	140
Screen description.....	142
Rear view monitor system precautions.....	144
Area displayed on screen.....	144
Differences between the screen and the actual road.....	145
The camera	144
When approaching three-dimensional objects.....	147
Receiving on the Bluetooth® phone.....	162
Incoming calls.....	162
Receiving traffic map information.....	136
Displaying traffic map information	136
Receiving weather information.....	134
Displaying weather information	134
Registering home.....	22
Registering preset destinations.....	24
Registering/connecting Bluetooth® device	42
Profiles	44
Registering a Bluetooth® audio player for the first time	43
Registering a Bluetooth® phone for the first time	42
Route guidance.....	224
Route guidance screen	224
During freeway driving.....	226
Route overview.....	225
Screen for route guidance	224
Turn list screen.....	228
Turn-by-turn arrow screen.....	228
When approaching intersection.....	227

ALPHABETICAL INDEX

S

Screen adjustment.....	40
Search operation.....	210
Searching by address.....	212
Searching by address book.....	216
Searching by coordinates.....	219
Searching by emergency.....	217
Searching by intersection and freeway.....	217
Searching by map.....	219
Searching by point of interest.....	213
Searching from previous destinations.....	216
Selecting search area.....	211
Setting home as destination.....	211
Setting preset destinations as destination.....	211
Setting Bluetooth® details.....	45
“Bluetooth Setup” screen.....	45
Connecting a Bluetooth® device.....	48
Deleting a Bluetooth® device.....	47
Editing the Bluetooth® device information.....	50
Registering a Bluetooth® device.....	46
“System Settings” screen.....	51
Setting home as the destination.....	27
Setup.....	111, 171, 244, 272
“Setup” screen.....	20
Some basics.....	68, 153
About the contacts in the contact list.....	155
Disc slot.....	70
Registering/connecting a Bluetooth® phone.....	153
Selecting an audio source.....	69
Sound settings.....	71
Turning the system on and off.....	68
USB/AUX port.....	70
Using the phone switch/microphone.....	154
Voice command system.....	72, 154
When selling or disposing of the vehicle.....	155
Starting route guidance.....	220
Pausing guidance.....	223
Starting route guidance.....	220
Steering switches.....	108

T

Talking on the Bluetooth® phone.....	163
Incoming call waiting.....	165
Things you should know.....	149
If you notice any symptoms.....	149
Tips for operating the audio system.....	113
Tips for the navigation system.....	254
Touch screen gestures.....	34
Touch screen operation.....	35
Traffic information.....	205
Displaying traffic information on the map.....	207
Traffic settings.....	248
Auto avoid traffic.....	249
My traffic routes.....	250
Screen for traffic settings.....	248
Troubleshooting.....	183
Typical voice guidance prompts.....	229

U

USB memory	93
Overview	93
Playing a USB audio	96
Useful information.....	134

V

Voice command system.....	123, 124
Using the voice command system	124
Voice command system operation	125
Voice command system operation.....	124
Voice settings	59
Voice settings screen	59

W

What to do if.....	183
--------------------	-----

X

XM Satellite Radio	83
Displaying the radio ID	87
How to subscribe to an XM Satellite Radio	85
If the satellite radio tuner malfunctions	88
Overview	83
Presetting a channel	87
Selecting a channel from the list	87

Map database information and updates

END USER LICENSE AGREEMENT

END USER TERM

The content provided by HERE ("Data") is licensed, not sold. By opening this package, or installing, copying, or otherwise using the Data, you agree to be bound by the terms of this agreement.

The Data is provided for your personal, internal use only and may not be resold. It is protected by copyright, and is subject to the following terms (this "End User License Agreement") and conditions which are agreed to by you, on the one hand, and HERE and its licensors (including their licensors and suppliers) on the other hand. For purposes of these terms, "HERE" shall mean (a) HERE North America, LLC with respect to Data for the Americas and/or the Asia Pacific region and (b) HERE Europe B.V. for Data for Europe, the Middle East and/or Africa.

The Data includes certain information and related content provided under license to HERE from third parties and is subject to the applicable supplier terms and copyright notices set forth at the following URL:http://corporate.navteq.com/supplier_terms.html.

TERMS AND CONDITIONS

License Limitations on Use: You agree that your license to use this Data is limited to and conditioned on use for solely personal, noncommercial purposes, and not for service bureau, timesharing or other similar purposes. Except as otherwise set forth herein, you agree not to otherwise reproduce, copy, modify, decompile, disassemble or reverse engineer any portion of this Data, and may not transfer or distribute it in any form, for any purpose, except to the extent permitted by mandatory laws.

License Limitations on Transfer: Your limited license does not allow transfer or resale of the Data, except on the condition that you may transfer the Data and all accompanying materials on a permanent basis if: (a) you retain no copies of the Data; (b) the recipient agrees to the terms of this End User License Agreement; and (c) you transfer the Data in the exact same form as you purchased it by physically transferring the original media (e.g., the CD-ROM or DVD you purchased), all original packaging, all Manuals and other documentation. Specifically, Multidisc sets may only be transferred or sold as a complete set as provided to you and not as a subset thereof.

Additional License Limitations: Except where you have been specifically licensed to do so by HERE in a separate written agreement, and without limiting the preceding paragraph, your license is conditioned on use of the Data as prescribed in this agreement, and you may not (a) use this Data with any products, systems, or applications installed or otherwise connected to or in communication with vehicles capable of vehicle navigation, positioning, dispatch, real time route guidance, fleet management or similar applications; or (b) with, or in communication with, including without limitation, cellular phones, palmtop and handheld computers, pagers, and personal digital assistants or PDAs.

Warning: This Data may contain inaccurate or incomplete information due to the passage of time, changing circumstances, sources used and the nature of collecting comprehensive geographic Data, any of which may lead to incorrect results.

No Warranty: This Data is provided to you “as is” , and you agree to use it at your own risk. HERE and its licensors (and their licensors and suppliers) make no guarantees, representations or warranties of any kind, express or implied, arising by law or otherwise, including but not limited to, content, quality, accuracy, completeness, effectiveness, reliability, fitness for a particular purpose, usefulness, use or results to be obtained from this Data, or that the Data or server will be uninterrupted or error free.

Disclaimer of Warranty: HERE AND ITS LICENSORS (INCLUDING THEIR LICENSORS AND SUPPLIERS) DISCLAIM ANY WARRANTIES, EXPRESS OR IMPLIED, OF QUALITY, PERFORMANCE, MERCHANTABILITY, FITNESS FOR A PARTICULAR PURPOSE OR NON-INFRINGEMENT. Some States, Territories and Countries do not allow certain warranty exclusions, so to that extent the above exclusion may not apply to you.

Disclaimer of Liability: HERE AND ITS LICENSORS (INCLUDING THEIR LICENSORS AND SUPPLIERS) SHALL NOT BE LIABLE TO YOU IN RESPECT OF ANY CLAIM, DEMAND OR ACTION, IRRESPECTIVE OF THE NATURE OF THE CAUSE OF THE CLAIM, DEMAND OR ACTION ALLEGING ANY LOSS, INJURY OR DAMAGES, DIRECT OR INDIRECT, WHICH MAY RESULT FROM THE USE OR POSSESSION OF THIS DATA; OR FOR ANY LOSS OF PROFIT, REVENUE, CONTRACTS OR SAVINGS, OR ANY OTHER DIRECT, INDIRECT, INCIDENTAL, SPECIAL OR CONSEQUENTIAL DAMAGES ARISING OUT OF YOUR USE OF OR INABILITY TO USE THIS DATA, ANY DEFECT IN THIS DATA, OR THE BREACH OF THESE TERMS OR CONDITIONS, WHETHER IN AN ACTION IN CONTRACT OR TORT OR BASED ON A WARRANTY, EVEN IF HERE OR ITS LICENSORS HAVE BEEN ADVISED OF THE POSSIBILITY OF SUCH DAMAGES. Some States, Territories and Countries do not allow certain liability exclusions or damages limitations, so to that extent the above may not apply to you.

Export Control: You agree not to export from anywhere any part of the Data or any direct product thereof except in compliance with, and with all licenses and approvals required under, applicable export laws, rules and regulations, including but not limited to the laws, rules and regulations administered by the Office of Foreign Assets Control of the U.S. Department of Commerce and the Bureau of Industry and Security of the U.S. Department of Commerce. To the extent that any such export laws, rules or regulations prohibit HERE from complying with any of its obligations hereunder to deliver or distribute Data, such failure shall be excused and shall not constitute a breach of this Agreement.

Entire Agreement: These terms and conditions constitute the entire agreement between HERE (and its licensors, including their licensors and suppliers) and you pertaining to the subject matter hereof, and supersedes in their entirety any and all written or oral agreements previously existing between us with respect to such subject matter.

Severability: You and HERE agree that if any portion of this agreement is found illegal or unenforceable, that portion shall be severed and the remainder of the Agreement shall be given full force and effect.

Governing Law: The above terms and conditions shall be governed by the laws of the State of Illinois (for Data for the Americas and/or the Asia Pacific region) or The Netherlands (for Data for Europe, the Middle East and Africa), without giving effect to (i) its conflict of laws provisions, or (ii) the United Nations Convention for Contracts for the International Sale of Goods, which is explicitly excluded. For any and all disputes, claims and actions arising from or in connection with the Data ("Claims"), you agree to submit to the personal jurisdiction of (a) the State of Illinois for Claims related to Data for the Americas and/or the Asia Pacific region provided to you hereunder, and (b) The Netherlands for Data for Europe, the Middle East and/or Africa provided to you hereunder.

Government End Users: If the Data is being acquired by or on behalf of the United States government or any other entity seeking or applying rights similar to those customarily claimed by the United States government, this Data is a “commercial item” as that term is defined at 48 C.F.R. (“FAR”) 2.101, is licensed in accordance with this End User License Agreement, and each copy of Data delivered or otherwise furnished shall be marked and embedded as appropriate with the following “Notice of Use” , and be treated in accordance with such Notice:

NOTICE OF USE

CONTRACTOR (MANUFACTURER/ SUPPLIER) NAME:

HERE

CONTRACTOR (MANUFACTURER/SUPPLIER) ADDRESS:

425 West Randolph Street, Chicago, IL 60606.

This Data is a commercial item as defined in FAR 2.101 and is subject to the End User License Agreement under which this Data was provided.

© 1987-2013* HERE. All rights reserved. *original publication date

If the Contracting Officer, federal government agency, or any federal official refuses to use the legend provided herein, the Contracting Officer, federal government agency, or any federal official must notify HERE prior to seeking additional or alternative rights in the Data.

© 1987-2013* HERE. All rights reserved. *original publication date

B. VISA. With respect to any VISA data, VISA specifically requires the following:

1. Licensee shall provide the Attribution to VISA with respect to the VISA data.

2. Licensee shall not allow data mining or downloading of the Information except in strictly limited quantities (a maximum of nine (9) locations per end-user search. An **end-user search** is a request by an end-user for a search of listings in a specific geographic area meeting certain criteria (for example, nearest listing to a waypoint or listings along a route segment). Any individual listing may be selected manually by the end-user for storage in a personal electronic address book or other form of memory in the navigation system. The personal electronic address book in the navigation system may be synchronized (not copied, reproduced, republished, uploaded, posted, transmitted, stored or distributed) with other devices operated by the end-user.

3. Licensee shall incorporate updates to the Data as soon as commercially feasible.

4. In addition to the general minimum terms included above, Licensee shall agree to require end-users to accept the following VISA-standard end user terms as a condition of access to the Data:

i.) All materials are the copyrighted property of AISIN and/or TELECOMMUNICATION SYSTEMS, INC. and its licensors. No material from this site may be copied, reproduced, republished, uploaded, posted, transmitted, stored, or distributed in any way, except that end user may download one listing (a location's name and address) on an individual non-automated basis per visiting session to the Licensee site or application, into end user's personal electronic address book. A personal electronic address book may not be shared by end user with other end users, nor may it be copied, reproduced, republished, uploaded, posted, transmitted, stored or distributed in any way. Use of the personal electronic address book must be for end user's personal, noncommercial use only.

ii.) End user may not use any material from AISIN's site or application for the purpose of compiling, enhancing, verifying, supplementing, or otherwise modifying VISA databases, lists, or directories of any kind, including, but not limited to, location databases, mailing lists, contact lists, marketing lists, geographic directories, or any other compilation or collation of information which is sold, rented, published, distributed, or in any manner supplied to a third party.

Certain business data provided by Infogroup © 2012, All Rights Reserved.



Certification

- Gracenote, the Gracenote logo and logotype, "Powered by Gracenote", MusicID, Playlist Plus and MediaVOCS are either registered trademarks or trademarks of Gracenote, Inc. in the United States and/or other countries



Gracenote[®] End User License Agreement - Music

This application or device contains software from Gracenote, Inc. of Emeryville, California ("Gracenote"). The software from Gracenote (the "Gracenote Software") enables this application to perform disc and/or file identification and obtain music-related information, including name, artist, track, and title information ("Gracenote Data") from online servers or embedded databases (collectively, "Gracenote Servers") and to perform other functions. You may use Gracenote Data only by means of the intended End-User functions of this application or device.

This application or device may contain content belonging to Gracenote's providers. If so, all of the restrictions set forth herein with respect to Gracenote Data shall also apply to such content and such content providers shall be entitled to all of the benefits and protections set forth herein that are available to Gracenote.

You agree that you will use Gracenote Data, the Gracenote Software, and Gracenote Servers for your own personal non-commercial use only. You agree not to assign, copy, transfer or transmit the Gracenote Software or any Gracenote Data to any third party. YOU AGREE NOT TO USE OR EXPLOIT GRACENOTE DATA, THE GRACENOTE SOFTWARE, OR GRACENOTE SERVERS, EXCEPT AS EXPRESSLY PERMITTED HEREIN.

You agree that your non-exclusive license to use the Gracenote Data, the Gracenote Software, and Gracenote Servers will terminate if you violate these restrictions. If your license terminates, you agree to cease any and all use of the Gracenote Data, the Gracenote Software, and Gracenote Servers. Gracenote reserves all rights in Gracenote Data, the Gracenote Software, and the Gracenote Servers, including all ownership rights. Under no circumstances will Gracenote become liable for any payment to you for any information that you provide. You agree that Gracenote, Inc. may enforce its rights under this Agreement against you directly in its own name.

The Gracenote service uses a unique identifier to track queries for statistical purposes. The purpose of a randomly assigned numeric identifier is to allow the Gracenote service to count queries without knowing anything about who you are. For more information, see the web page for the Gracenote Privacy Policy for the Gracenote service.

The Gracenote Software and each item of Gracenote Data are licensed to you "AS IS." Gracenote makes no representations or warranties, express or implied, regarding the accuracy of any Gracenote Data from the Gracenote Servers. Gracenote reserves the right to delete data from the Gracenote Servers or to change data categories for any cause that Gracenote deems sufficient. No warranty is made that the Gracenote Software or Gracenote Servers are error-free or that functioning of Gracenote Software or Gracenote Servers will be uninterrupted. Gracenote is not obligated to provide you with new enhanced or additional data types or categories that Gracenote may provide in the future and is free to discontinue its services at any time.

GRACENOTE DISCLAIMS ALL WARRANTIES EXPRESS OR IMPLIED, INCLUDING, BUT NOT LIMITED TO, IMPLIED WARRANTIES OF MERCHANTABILITY, FITNESS FOR A PARTICULAR PURPOSE, TITLE, AND NON-INFRINGEMENT. GRACENOTE DOES NOT WARRANT THE RESULTS THAT WILL BE OBTAINED BY YOUR USE OF THE GRACENOTE SOFTWARE OR ANY GRACENOTE SERVER. IN NO CASE WILL GRACENOTE BE LIABLE FOR ANY CONSEQUENTIAL OR INCIDENTAL DAMAGES OR FOR ANY LOST PROFITS OR LOST REVENUES.

© 2013 Gracenote, Inc. All rights reserved.

► For U.S. owners

I. Clear Channel Disclaimers

"Total Traffic Network, a division of Clear Channel Broadcasting, Inc., owns or holds the rights to the traffic, news, sports, weather, stocks and other data (the "TOTAL TRAFFIC-HD+ Data") and TOTAL TRAFFIC-HD+ network through which it is delivered, together the "TTN Service". Use of the TTN Service is subject to the terms of these Device End User Terms.

"The TTN Service is informational only. User assumes all risk of use. Total Traffic Network and its suppliers and licensors make no representations about the accuracy or timeliness of any of the TOTAL TRAFFIC-HD+ Data, including traffic and road conditions, route usability, or speed."

"TOTAL TRAFFIC-HD+ NETWORK DATA IS PROVIDED "AS IS," AND "WHERE IS". TOTAL TRAFFIC NETWORK AND ITS SUPPLIERS AND LICENSORS EXPRESSLY DISCLAIM ALL WARRANTIES WITH RESPECT TO THE DATA (INCLUDING, WITHOUT LIMITATION, THAT THE DATA WILL BE ERROR-FREE, WILL OPERATE WITHOUT INTERRUPTION OR THAT THE DATA WILL BE ACCURATE), EXPRESS, IMPLIED OR STATUTORY, INCLUDING, WITHOUT LIMITATION, THE IMPLIED WARRANTIES OF MERCHANTABILITY, NON-INFRINGEMENT, FITNESS FOR A PARTICULAR PURPOSE, OR THOSE ARISING FROM A COURSE OF DEALING OR USAGE OF TRADE."

"TOTAL TRAFFIC NETWORK AND ITS SUPPLIERS AND LICENSORS WILL NOT BE LIABLE TO YOU FOR ANY INDIRECT, SPECIAL, CONSEQUENTIAL, EXEMPLARY, OR INCIDENTAL DAMAGES (INCLUDING, WITHOUT LIMITATION, LOST REVENUES, ANTICIPATED REVENUES, OR PROFITS RELATING TO THE SAME) ARISING FROM ANY CLAIM RELATING DIRECTLY OR INDIRECTLY TO USE OF THE DATA, WHETHER A CLAIM FOR SUCH DAMAGES IS BASED ON WARRANTY, CONTRACT, TORT (INCLUDING, WITHOUT LIMITATION, NEGLIGENCE OR STRICT LIABILITY) OR ANY OTHER LEGAL THEORY."

II. The Weather Channel's (TWC's) Disclaimers

THE FOLLOWING TERMS APPLY TO THE USE OF ANY MATERIAL, DATA OR INFORMATION PROVIDED BY THE WEATHER CHANNEL, LLC ("THE WEATHER CHANNEL"), INCLUDING WEATHER-RELATED INFORMATION AND REPORTS, OBTAINED BY YOU OR OTHERS THROUGH THE TTN SERVICE ("THE WC DATA").

DISCLAIMER OF WARRANTIES.

YOUR USE OF THE WC DATA IS AT YOUR SOLE RISK. THE WC DATA IS PROVIDED ON AN "AS IS" AND "AS AVAILABLE" BASIS. THE WEATHER CHANNEL EXPRESSLY DISCLAIMS ALL WARRANTIES OF ANY KIND, WHETHER EXPRESS OR IMPLIED, INCLUDING, BUT NOT LIMITED TO THE IMPLIED WARRANTIES OF MERCHANTABILITY, FITNESS FOR A PARTICULAR PURPOSE AND NON-INFRINGEMENT. THE WEATHER CHANNEL MAKES NO REPRESENTATION OR WARRANTY THAT (i) THE WC DATA WILL MEET YOUR REQUIREMENTS, (ii) THE WC DATA WILL BE UNINTERRUPTED, TIMELY, SECURE, OR ERROR-FREE, (iii) THE RESULTS THAT MAY BE OBTAINED FROM THE USE OF THE WC DATA WILL BE ACCURATE OR RELIABLE, OR (iv) ANY ERRORS OR BUGS IN THE WC DATA WILL BE CORRECTED. ACCORDINGLY, THE WEATHER CHANNEL SHALL NOT BE RESPONSIBLE OR LIABLE FOR THE ACCURACY, USEFULNESS OR AVAILABILITY OF THE WC DATA.

LIMITATION OF LIABILITY.

YOU EXPRESSLY UNDERSTAND AND AGREE THAT THE WEATHER CHANNEL, ITS SUPPLIERS, ITS LICENSORS AND ITS AFFILIATE COMPANIES SHALL NOT BE LIABLE, UNDER ANY LEGAL THEORY, INCLUDING CONTRACT, TORT, NEGLIGENCE OR STRICT LIABILITY, FOR ANY DIRECT, INDIRECT, INCIDENTAL, SPECIAL, PUNITIVE, CONSEQUENTIAL OR EXEMPLARY DAMAGES, INCLUDING BUT NOT LIMITED TO, DAMAGES FOR LOSS OF PROFITS, GOODWILL, USE, DATA OR OTHER INTANGIBLE LOSSES (EVEN IF THE WEATHER CHANNEL HAS BEEN ADVISED OF THE POSSIBILITY OF SUCH DAMAGES), RESULTING FROM OR ARISING OUT OF YOUR USE OF, OR YOUR INABILITY TO USE, THE WC DATA, THIS AGREEMENT, OR ANY OTHER MATTER RELATING TO THE WC DATA. YOUR SOLE AND EXCLUSIVE REMEDY FOR ANY DISPUTE WITH THE WEATHER CHANNEL RELATED TO THE WC DATA OR CONTENT SHALL BE CANCELLATION OF RECEIPT OF THE WC DATA. SOME JURISDICTIONS DO NOT ALLOW THE EXCLUSION OF CERTAIN WARRANTIES OR THE LIMITATION OR EXCLUSION OF LIABILITY FOR INCIDENTAL OR CONSEQUENTIAL DAMAGES. ACCORDINGLY, SOME OF THE ABOVE LIMITATIONS MAY NOT APPLY TO YOU.

► U.S.A. (Without navigation function)

● **FCC ID: BABFT0045A**

● This device complies with part 15 of the FCC Rules. Operation is subject to the following two conditions: (1) This device may not cause harmful interference, and (2) this device must accept any interference received, including interference that may cause undesired operation.

● **FCC WARNING**

Changes or modifications not expressly approved by the party responsible for compliance could void the user's authority to operate the equipment.

● **CAUTION: Radio Frequency Radiation Exposure**

This equipment complies with FCC radiation exposure limits set forth for an uncontrolled environment and meets the FCC radio frequency (RF) Exposure Guidelines in Supplement C to OET65. This equipment should be installed and operated keeping the radiator at least 20 cm or more away from person's body (excluding extremities: hands, wrists, feet and ankles).

● **Co-location:** This transmitter must not be co-located or operated in conjunction with any other antenna or transmitter.

► Canada (Without navigation function)

● **IC: 2024B-FT0045A**

● This device complies with Industry Canada licence-exempt RSS standard(s). Operation is subject to the following two conditions: (1) this device may not cause interference, and (2) this device must accept any interference, including interference that may cause undesired operation of the device.

Le présent appareil est conforme aux CNR d'Industrie Canada applicables aux appareils radio exempts de licence. L'exploitation est autorisée aux deux conditions suivantes : (1) l'appareil ne doit pas produire de brouillage, et (2) l'utilisateur de l'appareil doit accepter tout brouillage radioélectrique subi, même si le brouillage est susceptible d'en compromettre le fonctionnement.

● **CAUTION: Radio Frequency Radiation Exposure**

This equipment complies with IC radiation exposure limits set forth for an uncontrolled environment and meets RSS-102 of the IC radio frequency (RF) Exposure rules. This equipment should be installed and operated keeping the radiator at least 20 cm or more away from person's body (excluding extremities: hands, wrists, feet and ankles).

ATTENTION: l'exposition aux rayonnements radiofréquence

- Cet équipement est conforme aux limites d'exposition aux rayonnements énoncées pour un environnement non contrôlé et respecte les règles d'exposition aux fréquences radioélectriques (RF) CNR-102 de l'IC. Cet équipement doit être installé et utilisé en gardant une distance de 20 cm ou plus entre le dispositif rayonnant et le corps (à l'exception des extrémités : mains, poignets, pieds et chevilles).

► Mexico (Without navigation function)

● **COFETEL: RCPFUFT13-1083**

- La operación de este equipo está sujeta a las siguientes dos condiciones: (1) es posible que este equipo o dispositivo no cause interferencia perjudicial y (2) este equipo o dispositivo debe aceptar cualquier interferencia, incluyendo la que pueda causar su operación no deseada.



►U.S.A. (With navigation function)

● **FCC ID: BABFT0044C**

● This device complies with Part 15 of the FCC Rules. Operation is subject to the following two conditions: (1) this device may not cause harmful interference, and (2) this device must accept any interference received, including interference that may cause undesired operation.

● **FCC WARNING**

Changes or modifications not expressly approved by the party responsible for compliance could void the user's authority to operate the equipment.

● **CAUTION: Radio Frequency Radiation Exposure**

This equipment complies with FCC radiation exposure limits set forth for an uncontrolled environment and meets the FCC radio frequency (RF) Exposure Guidelines in Supplement C to OET65. This equipment should be installed and operated keeping the radiator at least 20 cm or more away from person's body (excluding extremities: hands, wrists, feet and ankles).

● **Co-location:** This transmitter must not be co-located or operated in conjunction with any other antenna or transmitter.

►Canada (With navigation function)

● **IC: 2024B-FT0044C**

● This device complies with Industry Canada licence-exempt RSS standard(s). Operation is subject to the following two conditions: (1) this device may not cause interference, and (2) this device must accept any interference, including interference that may cause undesired operation of the device.

Le présent appareil est conforme aux CNR d'Industrie Canada applicables aux appareils radio exempts de licence. L'exploitation est autorisée aux deux conditions suivantes : (1) l'appareil ne doit pas produire de brouillage, et (2) l'utilisateur de l'appareil doit accepter tout brouillage radioélectrique subi, même si le brouillage est susceptible d'en compromettre le fonctionnement.

● **CAUTION: Radio Frequency Radiation Exposure**

This equipment complies with IC radiation exposure limits set forth for an uncontrolled environment and meets RSS-102 of the IC radio frequency (RF) Exposure rules. This equipment should be installed and operated keeping the radiator at least 20 cm or more away from person's body (excluding extremities: hands, wrists, feet and ankles).

ATTENTION: l'exposition aux rayonnements radiofréquence

- Cet équipement est conforme aux limites d'exposition aux rayonnements énoncées pour un environnement non contrôlé et respecte les règles d'exposition aux fréquences radioélectriques (RF) CNR-102 de l'IC. Cet équipement doit être installé et utilisé en gardant une distance de 20 cm ou plus entre le dispositif rayonnant et le corps (à l'exception des extrémités : mains, poignets, pieds et chevilles).

► Mexico (With navigation function)

● **COFETEL: RCPFUFT12-1493**

- La operación de este equipo está sujeta a las siguientes dos condiciones: (1) es posible que este equipo o dispositivo no cause interferencia perjudicial y (2) este equipo o dispositivo debe aceptar cualquier interferencia, incluyendo la que pueda causar su operación no deseada.



GU-5

Publication No.OM42A18U

Part No.01999-42A18

Printed in Japan 01-1408-00 □

ラブ4 Navigation (北米U)