

MDG (ALL)
INSTALLATION
INSTRUCTIONS

INSTALLATION INSTRUCTIONS

GAS

AUTOMATIC DRYER

PLEASE READ ALL INSTALLATION INSTRUCTIONS AND REQUIREMENTS BEFORE INSTALLING.

⚠ WARNING: For your safety the information in this manual must be followed to minimize the risk of fire or explosion or to prevent property damage, personal injury or loss of life.

- Do not store or use gasoline or other flammable vapors and liquids in the vicinity of this or any other appliance.

WHAT TO DO IF YOU SMELL GAS

- Do not try to light any appliance.
- Do not touch any electrical switch; do not use any phone in your building.
- Clear the room, building or area of all occupants.
- Immediately call your gas supplier from a neighbor's phone. Follow the gas supplier's instructions.
- If you cannot reach your gas supplier, call the fire department.

Installation and service must be performed by a qualified installer, service agency or the gas supplier.

⚠ ATTENTION: Pour votre sécurité, suivre les indications données dans ce manuel afin de réduire les risques d'incendie ou d'explosion et d'éviter dommages matériels, blessures et décès.

- Ne pas entreposer ni utiliser d'essence ou autres produits et vapeurs inflammables à proximité de cette sècheuse ou de tout autre appareil électroménager.

- QUE FAIRE S'IL Y A UNE ODEUR DE GAZ

- N'allumer aucun appareil.
- Ne toucher aucun commutateur électrique; ne pas utiliser le téléphone dans votre maison ou votre immeuble.
- Faire sortir tous les occupants de la pièce, du logement ou immeuble, ou de la proximité.
- Appeler la compagnie de gaz immédiatement en utilisant le téléphone d'un voisin. Suivre les instructions de la compagnie de gaz.
- En cas d'impossibilité de joindre la compagnie de gaz, appeler les pompiers.

Le montage et les réparations doivent être faits par un technicien qualifié, un prestataire de services ou la compagnie de gaz.

INSTALLING YOUR NEW DRYER

FOR YOUR SAFETY AND THE PROPER OPERATION OF YOUR NEW DRYER, THE DRYER MUST BE INSTALLED IN ACCORDANCE WITH ALL THE INSTALLATION REQUIREMENTS.

All literature should be removed from inside dryer and saved for future reference.

NOTE: DO NOT RAISE OR LOWER THE DRYER BY THE BACKGUARD.

1. To remove the corrugated crate base, place your foot on the base close to a leveling foot. Pushing down firmly with your foot, tilt the dryer away from you.
2. Repeat process with all leveling feet (4). Remove excess base by hand.
3. Remove film covering backguard for shipping purposes. Wipe clean of fingerprints.

GAS CONNECTIONS

The dryer must be installed in accordance with the Installation Requirements. **EQUIPPED FOR NATURAL GAS. FOR LP GAS INSTALLATION SEE PAGE 2.**

- TOOLS REQUIRED -

¼" DRIVER
PIPE WRENCH OR
ADJUSTABLE WRENCH

SCREWDRIVER
PUTTY KNIFE
PIPE SEAL COMPOUND
DUCT TAPE

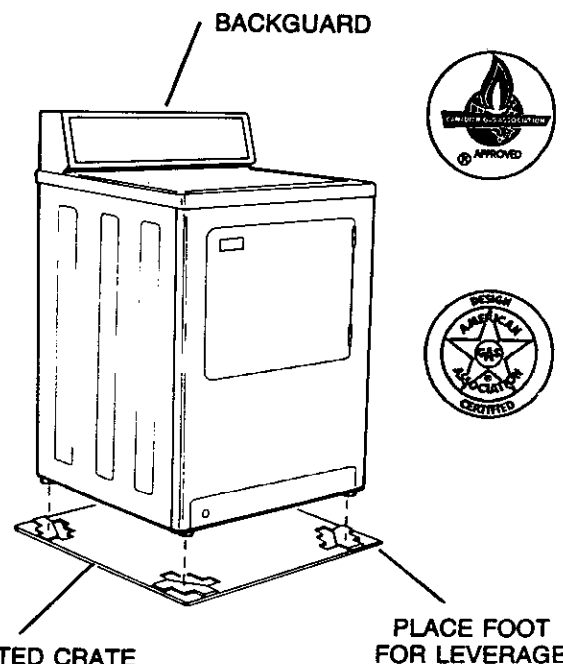

Read this before you start...

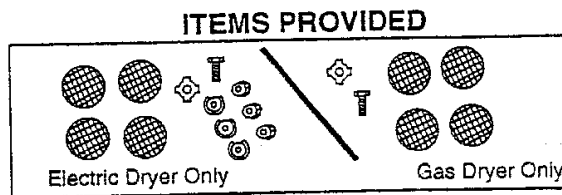
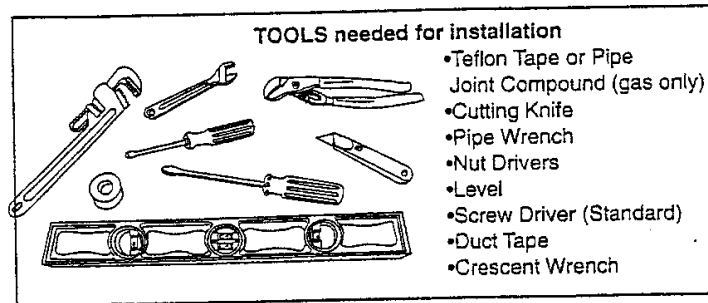

Proper installation is the responsibility of the owner.

HOWEVER, SERVICE CALLS PERFORMED AS A RESULT OF POOR SETUP, ADJUSTMENT, AND CONNECTION ARE THE RESPONSIBILITY OF THE INSTALLER.

Make sure you have everything necessary for proper installation

1. **GROUNDING ELECTRICAL OUTLET** is required. See Electrical Requirements.
2. **POWER CORD** for U.S. electric dryers.
3. **GAS LINES** (if a gas dryer) must meet National and Local Codes.
4. **EXHAUST SYSTEM** must be rigid metal or flexible stiff walled metal exhaust ducting. See Exhaust Requirements.

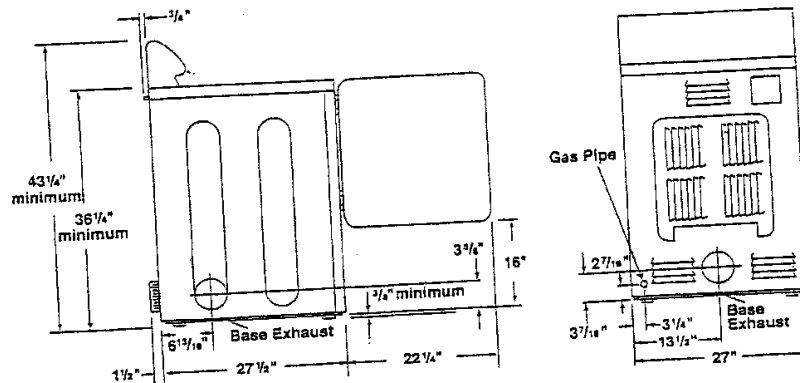

IMPORTANT TO INSTALLER

PLEASE READ THE FOLLOWING INSTRUCTIONS CAREFULLY BEFORE STARTING TO INSTALL THE DRYER. THESE INSTRUCTIONS SHOULD BE RETAINED FOR FUTURE REFERENCE.

REMOVE THE DOOR FROM ALL DISCARDED APPLIANCES SUCH AS DRYERS TO AVOID THE DANGER OF A CHILD SUFFOCATING.

LOCATION CONSIDERATIONS

The dryer should be located to permit adequate room in front for loading the dryer, and sufficient room behind the dryer for the exhaust system.

This dryer is factory-ready for rear exhaust. To exhaust out the bottom or left side use the accessory exhaust kit (see Accessories). Instructions are included with the kit.

It is important to make sure the room has adequate make-up air. The area where the dryer is located must not obstruct the flow of combustion or ventilating air.

On gas dryers, adequate clearance as noted on the data plate must be maintained to insure adequate air for combustion and proper operation of the dryer.

THE DRYER MUST NOT BE INSTALLED OR STORED IN AN AREA WHERE IT WILL BE EXPOSED TO WEATHER AND/OR WEATHER. THE DRYER AREAS IS TO BE KEPT CLEAR AND FREE FROM COMBUSTIBLE MATERIALS, GASOLINE AND OTHER FLAMMABLE VAPORS AND LIQUIDS. A DRYER PRODUCES COMBUSTIBLE LINT. THE AREA AROUND THE DRYER SHOULD BE KEPT FREE OF LINT.

ALCOVE OR CLOSET INSTALLATION

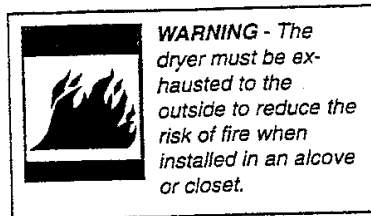

An appliance installed in a closet shall have no other fuel-burning appliance installed in the same closet.

Each opening area in the door must have a minimum of 36 square inches. These openings must not be obstructed. (Louvered door with equivalent air opening is acceptable).

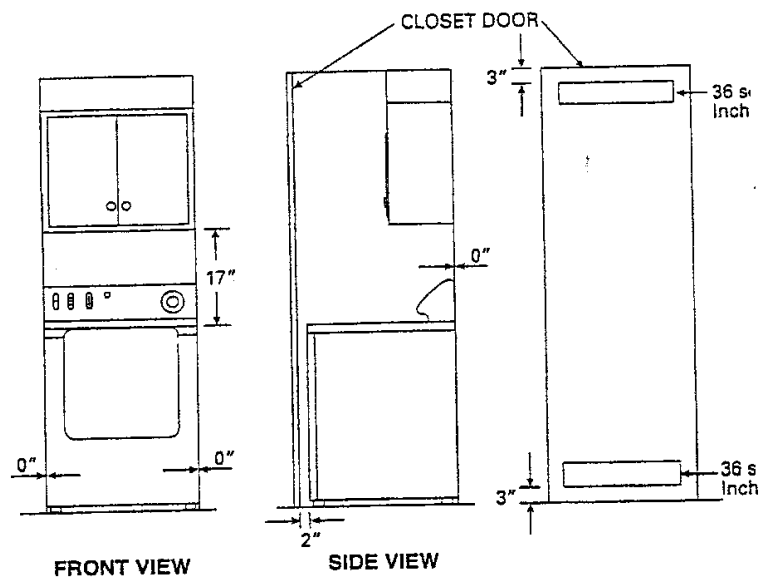

Minimum installation clearances. If possible, more clearance is recommended

MOBILE HOME INSTALLATION

The installation of the dryer in mobile homes must conform to the Manufactured Home Construction and Safety Standard Title 24 CFR, Part 32-80 (formerly the Federal Standard for Mobile Home Construction and Safety, Title 24 HUD (Part 280), 1975 for the United States), or CSA Standards Z240 (for Canada).

When installing a dryer in a mobile home, provisions for anchoring the dryer to the floor must be made. An anchor bracket kit is available with instructions (see Accessories). Locate in an area that has adequate makeup air. A minimum of 25 square inches of unobstructed opening is required.

All mobile home installations must be exhausted to the outside with the exhaust duct termination securely fastened to the mobile home structure, using materials that will not support combustion. The exhaust duct may not terminate beneath the mobile home. See the section on exhausting for more information.

EXHAUSTING

Exhausting the dryer to the outside will prevent large amounts of lint and moisture from being blown into the room.

In the United States:

- all gas dryers must be exhausted to the outside
- electric dryers located in a confined area such as a bedroom, bathroom, or closet must be exhausted to the outside.
- electric dryers not located in a confined area may be exhausted to the inside (see nonexhausted installations).

In Canada:

- all gas and electric dryers must be exhausted to the outside.

	<p>WARNING - plastic or nonmetal flexible duct presents a potential fire hazard.</p>
<p>NEVER USE PLASTIC OR NON METAL FLEXIBLE DUCT.</p>	
<p>If your existing ductwork is plastic, nonmetal or combustible, replace it with metal. Use only metal exhaust duct that will not support combustion to insure the containment of exhaust air, heat and lint.</p>	

Plastic flexible duct can kink, sag, be punctured, reduce airflow, extend drying times, and affect dryer operation.

USE A MINIMUM OF 4 INCH DIAMETER RIGID ALUMINUM OR RIGID GALVANIZED STEEL DUCT. Do not use smaller duct. Ducts larger than 4 inches in diameter can result in increased lint accumulation. Lint accumulation should be cleaned regularly. If flexible metal duct must be used, use the type with a stiff sheet metal wall. Do not use flexible duct with a thin foil wall. Serious blockage can result if flexible metal duct is bent too sharp. Never install any type of flexible duct in walls, ceilings or other concealed places.

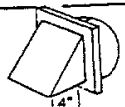
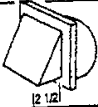
EXHAUST HOOD TYPE		
Number of 90° Turns		
Maximum length of 4-inch diameter rigid metal duct.		
0	65 ft.	59 ft.
1	54 ft.	48 ft.
2	44 ft.	38 ft.
3	36 ft.	30 ft.
4	28 ft.	22 ft.
Maximum length of 4-inch diameter flexible stiff walled metal duct.		
0	36 ft.	28 ft.
1	32 ft.	24 ft.
2	28 ft.	20 ft.
3	25 ft.	17 ft.
4	23 ft.	15 ft.

Keep exhaust duct as straight and short as possible. Exhaust systems longer than recommended can extend drying times, affect machine operation, and may collect lint. Secure joints with duct tape. Do not use screws.

DO NOT EXHAUST DRYER INTO ANY WALL, CEILING, CRAWL SPACE OR A CONCEALED PLACE OF A BUILDING, GAS VENT, ANY OTHER COMMON DUCT OR CHIMNEY. THIS COULD CREATE A FIRE HAZARD FROM LINT EXPELLED BY THE DRYER.

The exhaust duct should end with an exhaust hood with a swing out damper to prevent backdrafts and entry of wildlife. Never use an exhaust hood with a magnetic damper. The hood should have a least 12 inches of clearance between the bottom of the hood and the ground or other obstruction. The hood opening should point down. Never install a screen over the exhaust outlet.

When possible, do not exhaust the dryer directly over a window well in order to avoid lint build-up. Do not exhaust under a house or porch.

GAS REQUIREMENTS

Use only Natural or LP gases.

THE INSTALLATION MUST CONFORM WITH LOCAL CODES, OR IN THE ABSENCE OF LOCAL CODES, WITH THE NATIONAL FUEL GAS CODE ANSI/Z223.1, LATEST REVISION (FOR THE UNITED STATES), OR WITH THE CAN/CGA-B149 INSTALLATION CODES (FOR CANADA).

Gas dryers are equipped with a burner orifice for operation on NATURAL gas. If the dryer is to be operated on LP (liquid propane) gas, it must be converted for safe and proper performance and must be converted by a qualified service technician. Conversion kits from NATURAL to LP, or LP to NATURAL are available through your local Maytag dealer (see Accessories). If other conversions are required, check with the local gas utility for specific information concerning conversion requirements.

A 1/2" gas supply line is recommended and must be reduced to connect to the 3/8" gas line on the dryer.

The National Fuel Gas Code requires that an acceptable, approved manual gas shut off valve be installed within 6 feet of the dryer.

Additionally, a 1/8" N.P.T (National Pipe Thread) plugged tapping, accessible for test gauge connection, must be installed immediately upstream of the gas supply connection to the dryer.

The dryer must be disconnected from the gas supply piping system during any pressure testing of the system.

DO NOT re-use old flexible metal gas line. Flexible gas line must be design certified by American Gas Association (CGA in Canada). **NOTE:** Any pipe joint compound used must be resistant to the action of any liquefied petroleum gas.

NOTE: As a courtesy, most local gas utilities will inspect a gas appliance installation.

GAS IGNITION

This dryer uses an automatic ignition system to ignite the burner. **There is no constant burning pilot.**

ELECTRICAL REQUIREMENTS

NOTE: Wiring diagram is located inside the control console.

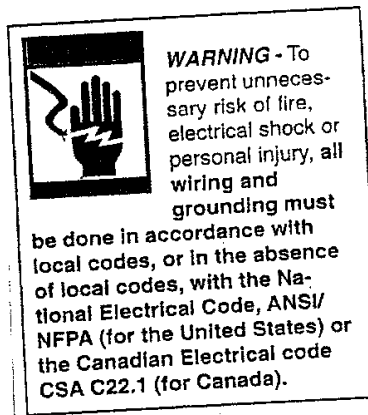

GROUNDING

This dryer must be grounded. In the event of malfunction or breakdown, the ground will reduce the risk of electrical shock by providing a path of least resistance for electric current.

GAS MODELS

This appliance is equipped with a cord having an equipment-grounding conductor and a grounding plug. The plug must be plugged into an appropriate outlet that is properly installed and grounded in accordance with all local codes and ordinances.

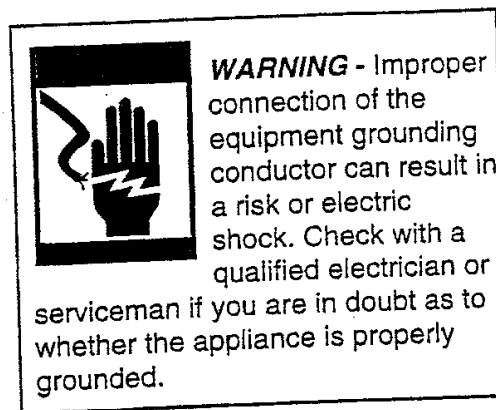

Do not modify the plug provided with the appliance - if it will not fit the outlet, have a proper outlet installed by a qualified electrician.

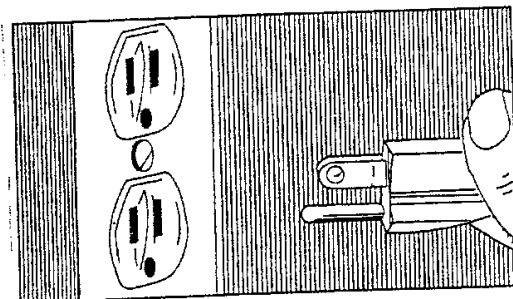

If a separate ground is required by local codes, an accessory kit is available. Connect ground wire to back of unit by using the wire found in the accessory kit. Secure other end of ground wire to a suitable external ground connection. The wire may be secured with the clamp (in the accessory kit) to a grounded COLD metal water pipe.

NEVER CONNECT GROUND WIRE TO PLASTIC PLUMBING LINES, GAS LINES OR HOT WATER PIPES.

NOTE: Cabinet ground screw and washer are found in the customer package.

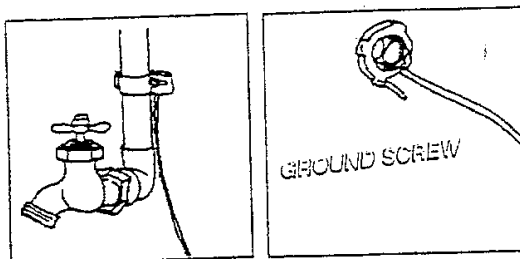

ELECTRICAL CONNECTIONS

BEFORE OPERATING OR TESTING, follow all grounding instructions in Grounding Section.

An individual branch (or separate) circuit serving only this appliance is recommended. **DO NOT USE AN EXTENSION CORD.**

Do not modify the plug provided with the appliance - if it will not fit the outlet, have a proper outlet installed by a qualified electrician.

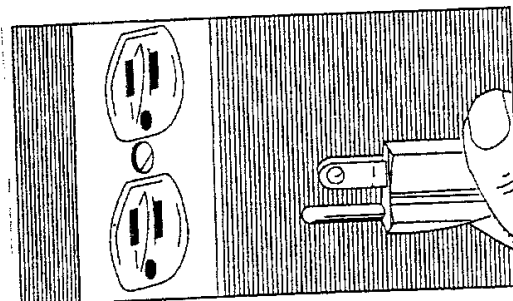

If a separate ground is required by local codes, an accessory kit is available. Connect ground wire to back of unit by using the wire found in the accessory kit. Secure other end of ground wire to a suitable external ground connection. The wire may be secured with the clamp (in the accessory kit) to a grounded COLD metal water pipe.

NEVER CONNECT GROUND WIRE TO PLASTIC PLUMBING LINES, GAS LINES OR HOT WATER PIPES.

NOTE: Cabinet ground screw and washer are found in the customer package.

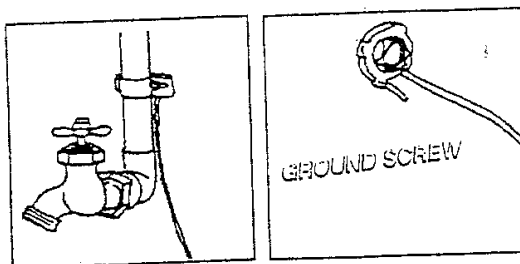

ELECTRICAL CONNECTIONS

BEFORE OPERATING OR TESTING, follow all grounding instructions in Grounding Section.

An individual branch (or separate) circuit serving only this appliance is recommended. **DO NOT USE AN EXTENSION CORD.**

GAS MODELS

A 120 volt, 60 Hz electrical supply, with a 15 ampere fuse or circuit breaker is required.

ELECTRIC MODELS

To avoid the possibility of electrical shock, the dryer must not be connected to a 120 volt 2-wire circuit.

The electrical supply circuit should be fused through a 30 ampere fuse or circuit breaker on both sides of the line.

If a power cord is used, the cord should be plugged into a 30 ampere receptacle.

U.S. MODELS

Maytag electric dryers are manufactured to operate on 120/240 volt, 60 Hz AC approved electrical service. The dryer must be converted to operate on a 120/208 volt electrical system. A heating element conversion kit is available (see Accessories).

The power cord is NOT provided with U.S. electric model dryers.

IMPORTANT: When permitted by local codes, the dryer electrical supply may be connected by means of a new power supply cord kit, marked for use with clothes dryer, that is U.L. listed, rated at 120/240 volts minimum, 30 amperes with three No. 10 copper wire conductors terminated with closed loop terminals, open end spade lugs with turned up ends or with tinned leads.

Do not reuse a power supply cord from an old dryer. The power cord or electric supply wiring must be retained at the dryer cabinet with a suitable UL listed strain relief.

If the dryer is to be installed in a mobile home or an area where local codes do not permit grounding through neutral, only a 4 conductor power cord, rated and terminated as above, may be used.

CANADIAN MODELS

All Canadian models are shipped with the power cord attached.

NOTE: It is not permissible to convert a dryer in Canada to 208 volts.

ADDITIONAL INFORMATION - 50 HERTZ OPERATION

This Maytag dryer model is manufactured for operation on 60 Hz AC approved electrical service. This model is not designed for use on 50 Hz AC electrical service and conversion of the product from 60 to 50 HZ operation is not recommended. For additional information on 50 Hz products, write

MAYTAG INTERNATIONAL, INC.
8700 BRYN MAWR AVE.
CHICAGO, IL 60631
Phone 773-714-0100

INSTALLATION ACCESSORIES

- Vent Hood - 4" (10.16 cm) opening
- Aluminum Pipe - 4" x 24" (10.16 cm x 60.96 cm)
- Aluminum Elbow - 4" (10.16 cm)
- Aluminum Window Plate - 15" x 20" (38.10 cm x 50.80 cm) - 4" (10.16 cm) hole
- Exhaust Deflector Kit. (U.S. Electric Models Only)
- Flexible Aluminum Vent Duct - 4" (10.16 cm diameter - 38" (81.28 cm) length stretches to 8' (2.44 m)
- Clamp for Flexible Aluminum Duct
- Exhaust Duct Kit for Base or Left Side Exhausting
- Dacron Lint Bag
- Bracket for Exhaust Deflector
- Rectangular Vent Kits
- Natural to LP Conversion Kit
- LP to Natural Conversion Kit
- Anchor Bracket Kit
- Heating Element Conversion Kit.
- Exhaust Kit
- Grounding Kit

REPLACEMENT PARTS AND ACCESSORIES

If your dryer requires replacement parts or accessories, contact the dealer from who you purchased your dryer or Maytag Customer Service, PO Box 2370, Cleveland, TN 37320-2370. Phone 423-472-3333, for information on the nearest authorized Maytag Parts Distributor.

TO INSTALL.....

1. Move dryer to an appropriate location for installation. Consider installing the dryer before the washer in side by side installations to allow access to gas, electrical and exhaust connections.

Lay two of the carton corner posts on the floor. Tip the dryer forward on its front so it will lay across both corner posts.

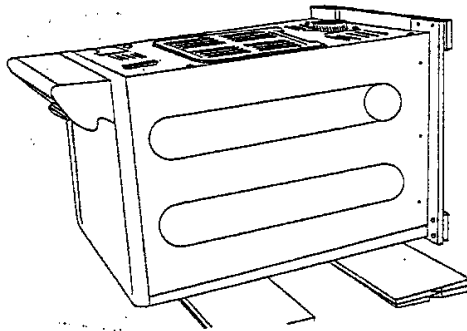

2. Remove the crate wires holding the crate base to the base frame. This can be done with a screwdriver.

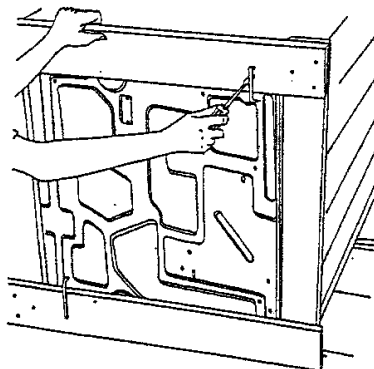

3. Loosen the leveling locking nuts and install the vinyl feet.

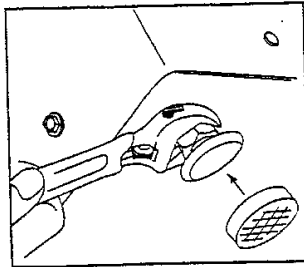

4. Set the dryer back in an upright position.

5. Review the exhaust section in the previous section before installing the exhaust system. Install the ductwork from the dryer to the exhaust hood. The crimped end of the duct sections must point away from the dryer. **DO NOT** use sheet metal screws when assembling ducting. These joints should be taped. **Never use plastic flexible exhaust material.**

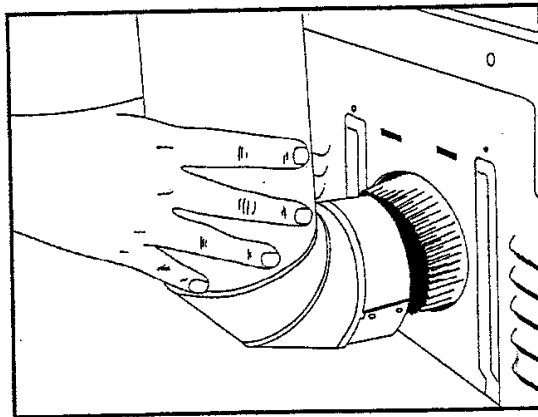

Tip for tight installations: install a section of exhaust system to the dryer before moving the dryer in place. Use duct tape to secure this section to the dryer but do not cover louvers in dryer cabinet.

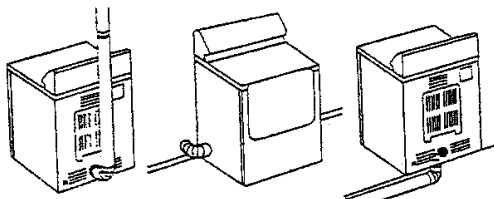

6. GAS DRYER SECTION

To Make Gas Connection - *Review gas requirements in previous section of these instructions.*

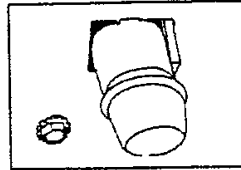

1. Remove the pipe thread protective cap.

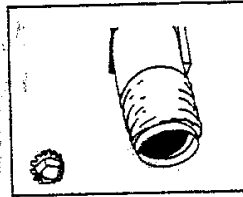

2. Apply pipe joint compound or about 1 1/2 wraps of Teflon tape over all threaded connections. **NOTE:** Pipe joint compound must be resistant to the action of any liquefied petroleum gas.

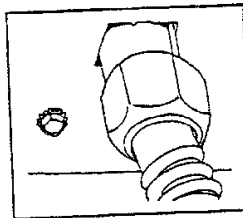

3. Connect the gas supply to the dryer. An additional fitting is required to connect the 3/4" female threaded end of a flexible connector to the 3/8" male threaded end on the dryer. Securely tighten the gas line fitting over threads.
4. Turn on the gas supply. Check all gas connections for leaks using a soap solution. If bubbles occur, tighten the connections and recheck. **DO NOT use an open flame to check for gas leaks.**

ELECTRIC DRYER SECTION

To Make the Electrical Connection - *Review the electrical requirements in the previous section of these instructions.*

IMPORTANT - The dryer frame is grounded to the neutral conductor at the terminal block. If the dryer is installed in a mobile home, or if local codes do not permit grounding through the neutral, refer to **4 WIRE SYSTEM CONNECTION**.

Remove the terminal block cover plate.

Insert the power cord with a U.L. listed strain relief through the hole provided in the cabinet near the terminal block. **Note: a strain relief must be used.**

3-WIRE SYSTEM CONNECTIONS

Do not loosen the nuts already installed on the terminal block. Be sure they are tight. Use a 3/8" deep well socket.

If the power cord has terminals, place the terminals over the existing nuts on the posts. The neutral (white or center wire on the power cord) conductor must always be connected to the center (silver colored) post of the terminal block.

Secure in place using the nuts provided in the accessories package. If the power cord does not have terminals, use the cupped washer ahead of the nuts.

Be sure the terminal block nuts are tight. Secure the power cord in position. Tighten the strain relief screw(s) in order to clamp the strain relief to the cord.

Replace the terminal block cover.

BEFORE OPERATING OR TESTING, follow the ground directions in the previous section.

WARNING: If converting from a 4-wire electrical system to a 3-wire, the ground strap must be reconnected to the terminal block support to ground the dryer frame to the neutral conductor.

4-WIRE SYSTEM CONNECTION

Remove the ground strap screw from the terminal block support. Fold the ground strap over so both ends of the ground strap are attached to the center terminal block post.

Connect the neutral (white) conductor of the cord to the center (silver colored) post of the terminal block. Connect the grounding (green) wire of the cord to the terminal block support using the ground strap screw.

Connect the red and black wires of the cord to the outer posts of the terminal block.

Be sure the terminal block nuts are on tight. Secure the power cord in position. Tighten the strain relief screw(s) in order to clamp the strain relief to the cord.

Replace the terminal block cover.

WARNING: If converting from 4-wire electrical systems to 3-wire, the ground strap must be reconnected to terminal block support to ground the dryer frame to the neutral conductor

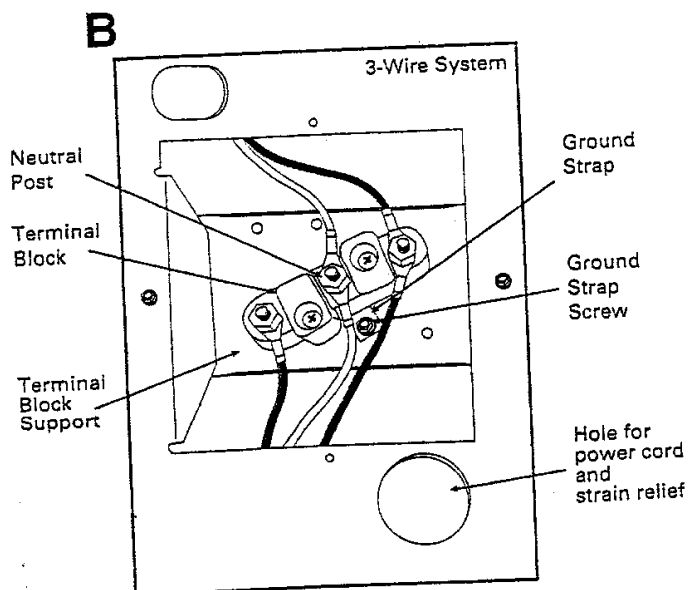
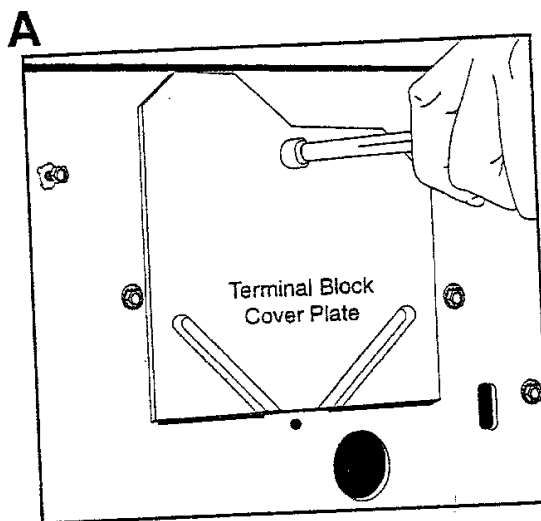

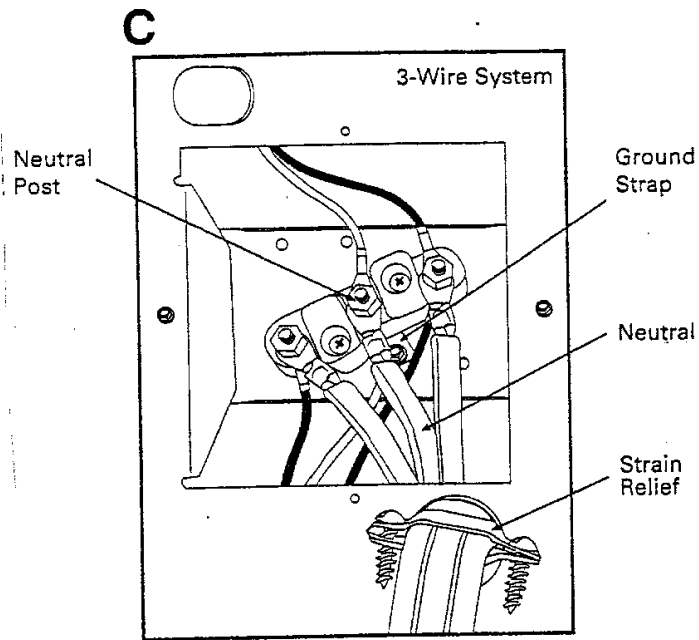

- Improper connection of the equipment-grounding conductor can result in a risk of electrical shock. Check with a qualified electrician or service man if you are in doubt as to whether the appliance is properly grounded. Do not modify the plug provided with the appliance - if it will not fit the outlet, have a proper outlet installed by a qualified electrician.

- To prevent unnecessary risk of fire, electrical shock or personal injury, all wiring and grounding must be done in accordance with the National Electrical Code ANSI/NFPA, No. 70-Latest Revision (for U.S.) or the Canadian Electrical Code CSA C22.1-Latest Revision and local codes and ordinances. It is the personal responsibility and obligation of the appliance owner to provide adequate electrical services for this appliance.

- All gas installations must be done in accordance with the National Fuel Gas Code ANSI/Z223.1-Latest Revision (for the United States) or the CAN/CGA-B149 Installation Codes-Latest Revision (for Canada) and local codes and ordinances.



7. With a level, check the dryer, and make necessary adjustments to the leveling legs. Once level, tighten the leveling leg locking nuts with a wrench.

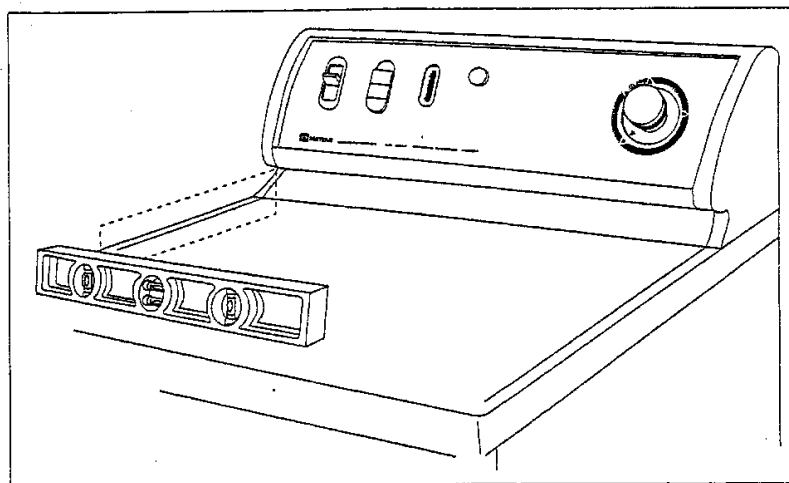

8. The dryer door direction can be reversed.

1. If the dryer is plugged in, unplug the dryer from the electrical service.
2. Remove the hinge hole covers and crews. Move the door catch cover to the opposite side.
3. While supporting the door, remove 2 screws in the hinges that secure the hinges to the cabinet.
4. Remove door by lifting slightly at hinges and pulling the hinge tabs out of the hinge slots.
5. Move the following parts to the opposite side of the of the door: 2 hinges and 4 hinge screws, 4 door screws, door strike and screw, inner door cover plate and screw.
6. Attach the door to the opposite side of the cabinet using the 2 counter sunk hinge screws (See below).
7. Driving the lower hinge screw first will help to align the door and hinges.
8. Replace the hinge hole covers and screws in the opposite side.

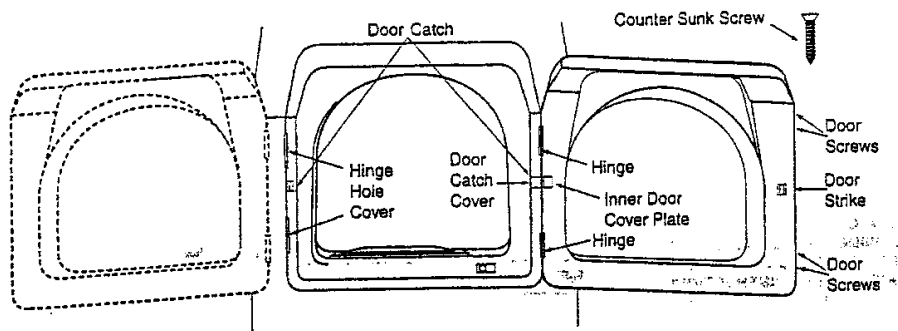

9. At this time, make sure all gas, exhaust and electrical connections are complete. Plug dryer in, and check operation by using the checklist below.

10. (GAS MODELS ONLY) - The burner may not ignite initially due to air in the gas line. Allowing the dryer to operate on a heat setting will purge the line. If the gas does not ignite within five minutes, turn the dryer off and wait 5 minutes. Be sure the gas supply to the dryer has been turned on. In order to confirm gas ignition, check the exhaust for heat.

FINAL INSTALLATION CHECK LIST

- Dryer is plugged into electrical outlet and is properly grounded.
- Exhaust ductwork is hooked up and joints taped.
- Plastic flexible duct is NOT used.
- Use only rigid or stiff walled flexible metal vent material.
- Dryer is level with all legs firmly on the floor, with the lock nuts tightened.
- Vinyl feet have been installed.
- Gas Models - Gas is turned on, there are no gas leaks.
- Dryer runs.
- Dryer heats.
- Dryer shuts off.
- Demonstrate use to customer.

**PARTS AND LITERATURE ARE PACKAGED INSIDE
OF DRYER DRUM**