

# *NEPTUNE*

**HIGH-EFFICIENCY WASHER**

**INSTALLATION INSTRUCTIONS**

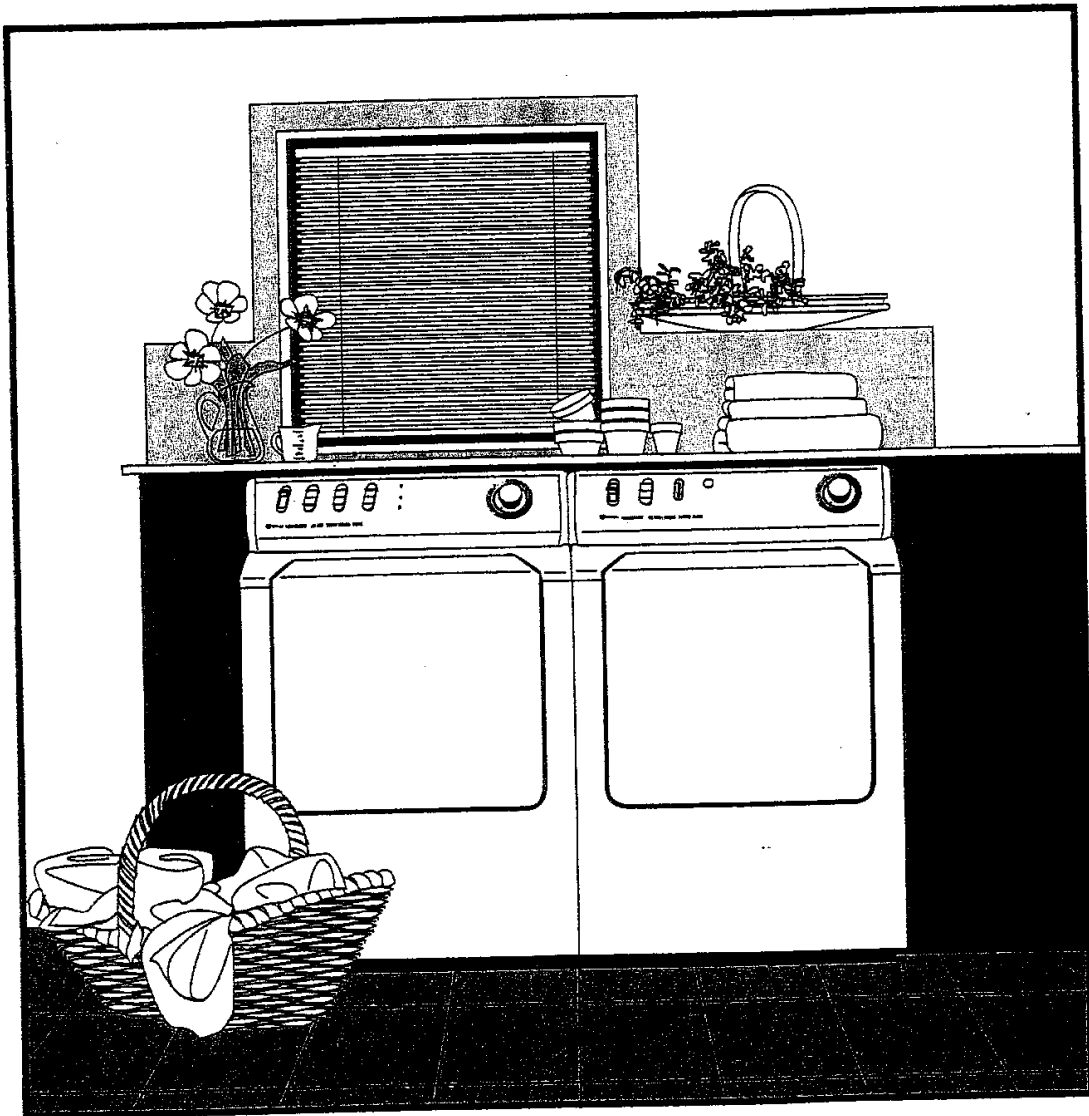

**LEAVE THESE INSTRUCTIONS WITH THE OWNER**

## REQUIREMENTS

120 Volt, 60 Hz.      15 AMP Fuse or Circuit Breaker

Individual branch circuit serving only the washer is recommended. The washer is equipped with a power cord. **NEVER USE AN EXTENSION CORD.**

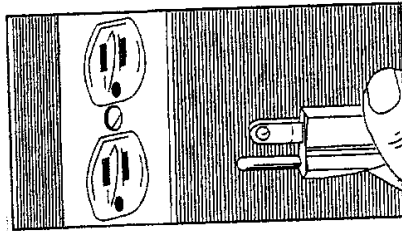

## GROUNDING

**ELECTRICAL GROUND IS REQUIRED ON THIS APPLIANCE.**

Appliance is equipped with a power cord having a 3-prong grounding plug for use in a properly installed and grounded outlet.

## ADDITIONAL GROUNDING CONNECTIONS

If a separate ground is required by local codes, an accessory kit is available. Connect the ground wire to the back of the unit by using the wire found in the accessory kit. Secure the other end of ground wire with the clamp (also in the accessory kit) to a grounded **COLD** metal water pipe. **NOTE: Cabinet ground screw and washer are found in the customer package.**

**NEVER CONNECT GROUND WIRE TO PLASTIC PLUMBING LINES, GAS LINES OR HOT WATER PIPES.**

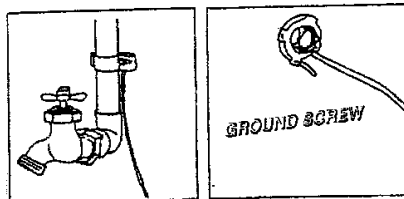

## **WATER**

Water pressure of 30 to 120 p.s.i. is required to correctly fill the washer in the proper time. Pressures of less than 30 p.s.i. may cause a failure in the water valve or the fill times to be extended past what the washer controls will normally allow. The water valve may also not shut off completely.

Hot and cold water faucets must be within 4 feet of the back of the washer for inlet hoses provided with the washer. **NOTE:** Accessory inlet hoses are available in various lengths up to 10 feet for faucets more than 4 feet from the back of the washer.

**TO AVOID THE POSSIBILITY OF WATER DAMAGE, SHOULD A HOSE LEAK, ALWAYS HAVE FAUCETS ACCESSIBLE AND TURN OFF FAUCETS WHEN WASHER IS NOT IN USE.**

Water heater should be set to deliver a minimum of 120 degrees to 140 degrees F (49-60 degrees C) water to the washer.

## **DRAIN FACILITY**

Recommended height of the standpipe is 36". If the standpipe is less than 24" high, the drain hose should be routed through the clip to raise the hose to the proper height. Standpipe must be large enough to accept the outside diameter of the drain hose.

*Without the 24" high elevation, water may run out of the washer prematurely.* For installations with less than a 24" high standpipe, please refer to the section titled: **FLOOR DRAIN INSTALLATION.**

**THE WASHING MACHINE MUST NOT BE STORED IN AN AREA WHERE IT WILL BE EXPOSED TO WATER AND/OR WEATHER.**

## **FLOORING**

For best performance the washer must be installed on a solidly constructed floor. Wood floors may need to be reinforced to minimize vibration and / or unbalanced load situations. Carpeting and soft tile surfaces are contributing factors in vibration and / or tendency for a washer to move slightly during the spin cycle. Never install the washer on a platform or weak supported structure.

## **LOCATION CONSIDERATIONS**

It is recommended the washer never be installed in areas where water may freeze since the washer will always maintain some water in the water valve, pump and hose areas. This can cause damage to belts, pump, hoses and other components. Operating temperature should be above 60 degrees F.

## **ALCOVE OR CLOSET INSTALLATION**

### **MINIMUM CLEARANCES FOR CLOSET AND ALCOVE INSTALLATIONS**

**SIDES - 0 in., REAR - 1 in.**

**TOP - 2 in., CLOSET FRONT - 0 in.**

The closet front must have a total unobstructed air opening of 72 sq.in. minimum. A louvered door with equivalent air opening is acceptable.

### **IMPORTANT TO INSTALLER**

**PLEASE READ THE FOLLOWING INSTRUCTIONS CAREFULLY BEFORE STARTING TO INSTALL THE WASHING MACHINE. THESE INSTRUCTIONS SHOULD BE RETAINED FOR FUTURE REFERENCE.**

**REMOVE THE DOOR FROM ALL DISCARDED APPLIANCES TO AVOID THE DANGER OF A CHILD SUFFOCATING.**

## ADDITIONAL INFORMATION

### 50 HERTZ OPERATION

This Maytag appliance is manufactured for operation on 60 Hz AC approved electrical service. This model is not designed for use on 50 Hz AC electrical service and conversion of the product from 60 to 50 Hz operation is not recommended. For additional information on 50 Hz products, write:

MAYTAG INTERNATIONAL, INC.  
8700 BRYN MAWR AVE.  
CHICAGO IL 60631  
Phone 773-714-0100

### CABINET DIMENSIONS

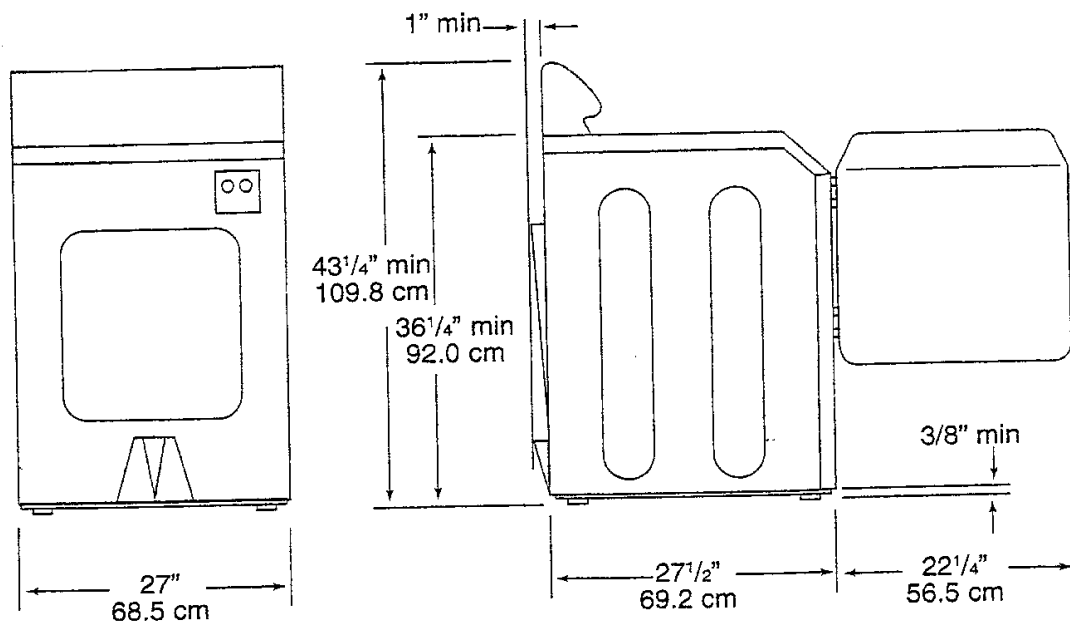

## Read this before you start.....

TOOLS needed for installation.

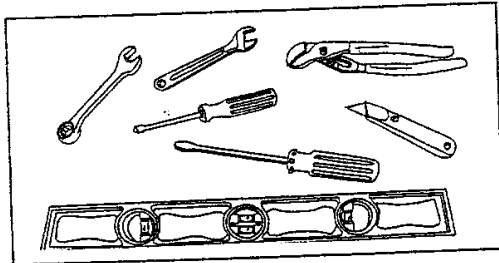

- cutting knife
- channel lock
- 5/16 nut driver
- level
- crescent wrench
- screwdriver-flatblade
- 1/2" Box end wrench

Items provided.

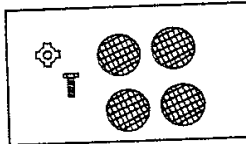

## STEP ONE - PREPARE WASHER

1. Carefully remove any packaging materials from the outside of the washer. Set aside two corner posts for installation. **IMPORTANT:** Notice that the hoses and power cord are tied up with a shipping strap. The strap **SHOULD NOT BE CUT OR REMOVED** until the machine is ready to be installed.

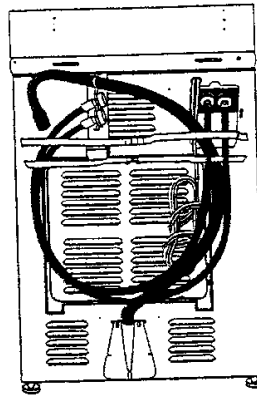

2. Locate the metal buckles attached to the shipping straps at the back of the washer. Carefully cut away straps near both buckles, completely removing both buckles from the washer. Pull loose straps from back of washer one at a time until all straps have been removed.

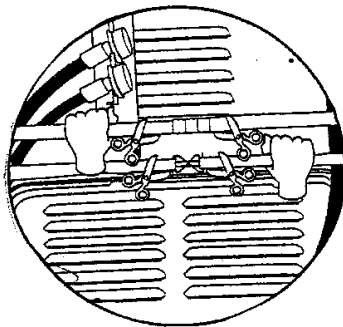

3. Lay two corner posts behind the washer and gently tip the washer over on to its back.

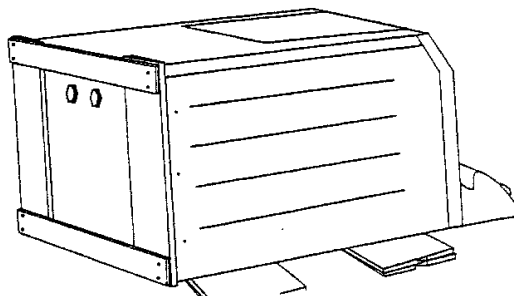

4. Remove the crate bottom from the washer.

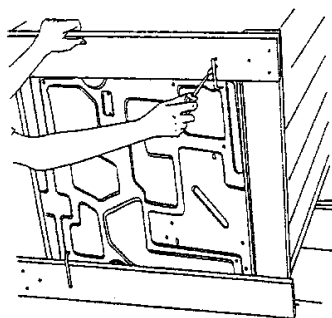

5. Locate two 1/2" hex shipping bolts on bottom of metal base. Remove both bolts, freeing the tub and suspension. **DO NOT BE ALARMED** as the last bolt is removed, the tub will jump to a position where it is resting against the back of the washer.

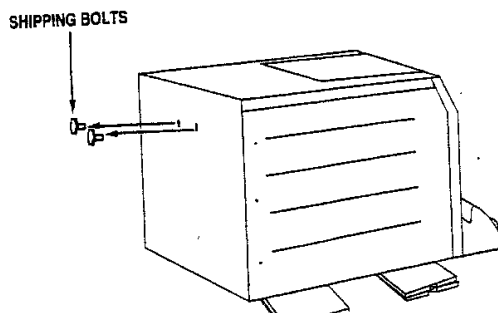

6. Loosen the four adjustable washer legs and lock nuts. Install vinyl feet found in installation package. Feed can be more easily installed when immersed in hot water before installing. Carefully raise the washer back to an upright position.

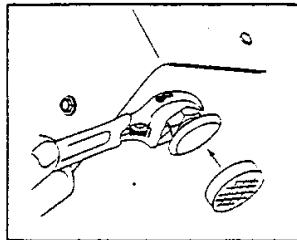

## STEP 2 - INSTALL THE WASHER

1. Install gooseneck end of drain hose into standpipe. Be sure an air-tight connection is **NOT** made between the drain hose and the standpipe. Standpipe must be at least 24" high. 36" high is recommended. **NOTE:** If drain standpipe is in excess of 5 feet above floor level, install pump accessory kit, part number 22002136. **NOTE:** Caution must always be exercised to avoid "kinking" the drain hose. For best performance the drain hose should not be restricted in any way, through elbows, couplings or excessive lengths.

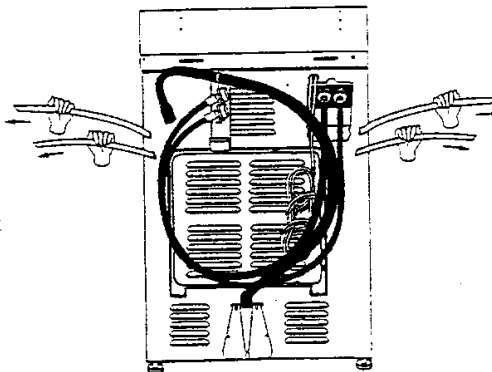



2. Connect inlet hoses to water supply using screen washer at faucet connections.
3. Plug power cord into a grounded 120 volt 60 Hz approved electrical service protected by a 15 amp fuse or comparable circuit breaker. This washer is grounded through the third prong of the power cord when plugged into a three prong grounded receptacle.

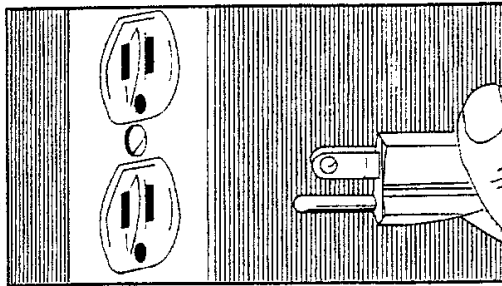

**NOTE: To prevent the possibility of electrical shock, this washer (as is the case with other electrical appliances) *must* be adequately grounded.**

It is the responsibility of the installer to assure the washer is adequately grounded at the point of installation taking into consideration the local conditions, codes and requirements.

4. Slide washer into position. **Do not kink drain hose. NOTE: the washer must be leveled on all 4 edges. To properly level a machine, the top cover and the front panel must be securely fastened. A carpenter's level should be used on all 4 edges of the top cover.**
5. Slide the washer out of position to either raise or lower the leveling leg required to level or stabilize the washer securely on all four legs. Slide the washer back into position to confirm levelness and solidness to the floor. **When satisfied the washer is level, tighten the locking nuts up against the base of the washer.** This will secure the leveling legs in place.

## FLOOR DRAIN INSTALLATION

If a floor drain is used, route the drain hose through the drain hose strap (as shown) before routing to the drain. For installations where the drain hose cannot be conveniently elevated to 24", the drain hose must be supported by the drain hose strap on the back of the washer.

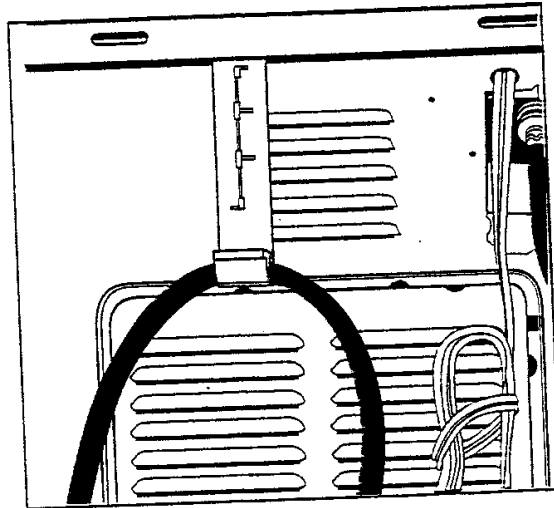

## DOOR REVERSAL

Clothes washer door swing direction can be successfully changed using the following procedure:

1. Swing door fully open and support it while removing four hinge screws (which hold hinges to door assembly).
2. Set door aside and transfer four color matched door screws to the opposite side of the door assembly.
3. Remove one screw holding top hinge to cabinet and one screw holding top hinge cover to cabinet (opposite side).
4. Remove hinge and bracket from cabinet by moving them up and down to a position where they are related.
5. Install hinge and bracket in swapped locations and drive screws to attach them securely to the cabinet.
6. Compare top hinge and top bracket to bottom hinge and bottom bracket for correct assembly position.
7. Repeat procedures 4 - 6 for bottom hinge to cabinet and bottom bracket to cabinet.
8. Support door in fully open position on hinge side and drive four screws to securely attach hinges to door assembly.
9. Close door and check to see that clothes washer operates properly.

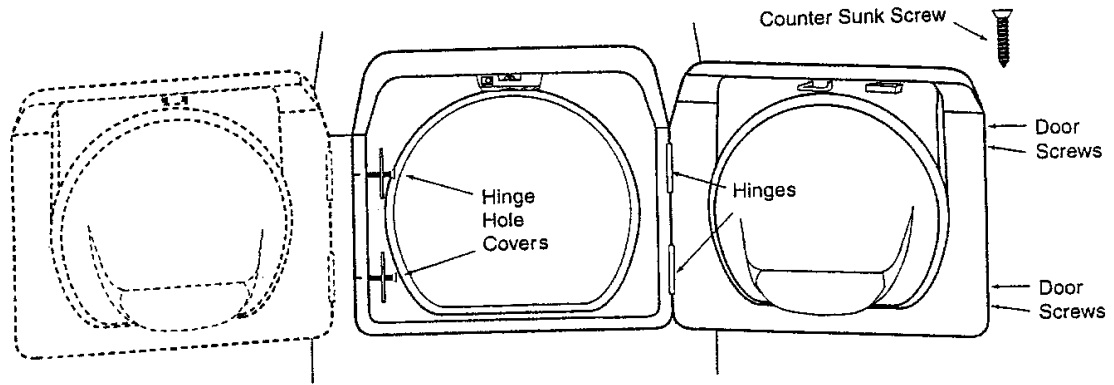

Improper connection of the equipment-grounding conductor can result in a risk of electrical shock. Check with a qualified electrician or serviceman if you are in doubt as to whether the appliance is properly grounded. Do not modify the plug provided with the appliance - if it will not fit the outlet, have a proper outlet installed by a qualified electrician.

### **IMPORTANT SAFETY PRECAUTIONS**

To prevent unnecessary risk of fire, electrical shock or personal injury, all wiring and grounding must be done in accordance with the National Electrical Code ANSI/NFPA 70-Latest Revision and local codes and ordinances. It is the personal responsibility and obligation of the appliance owner to provide adequate electrical service for this appliance.

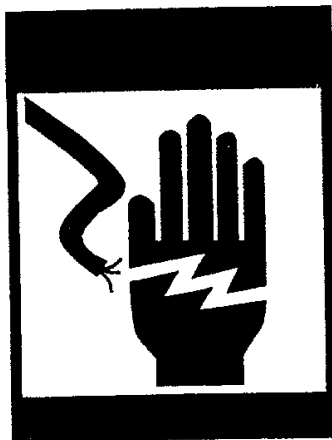

## FINAL INSTALLATION CHECKLIST

Instruction and Installation Kit have been removed from tub.

Shipping bolts and straps have been removed.

Vinyl feet have been installed.

Washer is plugged into electrical outlet and is properly grounded.

Water is turned on and checked for leaks at faucet and water valve connections.

Drain hose is properly located into drain facility and is not kinked.

Washer has been properly leveled. All legs should be firmly on the floor and lock nuts **MUST** be tightened.

Washer fills properly on all temperature selections.

Test for proper operation by running the washer through a complete cycle.

1. Select Cotton/Sturdy, Hot/Cold and Max Extract. Make sure the Extra Rinse option is not selected.
2. Set the timer into the Heavy-Normal-Light wash band and press the Start/Stop button.
3. Verify the washer is filling from the hot water valve.
4. Verify the washer stops filling
5. Set the timer into the Rinse 3 Increment and press the Start/Stop button to restart the washer.
6. Verify the washer is filling from the cold valve.
7. Verify the washer stops filling.
8. Advance the timer one increment into Spin.
9. Verify the washer spins. This will take several minutes as the door needs to lock and distribute the load.
10. Pull on the door to make sure it has locked.
11. Reset washer to start position.

## **FOR TECHNICAL ASSISTANCE, REPLACEMENT PARTS AND ACCESSORIES**

For technical assistance or if your washer requires replacement parts or accessories, contact **MAYTAG CUSTOMER SERVICE**, toll-free **1-888-4-Maytag** for information on the nearest authorized Maytag Parts Distributor.

Proper installation is the responsibility of the owner; **SERVICE CALLS PERFORMED AS A RESULT OF IMPROPER SETUP, ADJUSTMENT AND CONNECTION ARE THE RESPONSIBILITY OF THE INSTALLER.**